

FC1400

Operation Manual



Ver. 2.40

2022.02.22

Document Number : BN-OP-FC14



www.ebionet.com

Warranty Period

- This product is manufactured and passed through strict quality control and through inspection.
- Compensation standard concerning repair, replacement, refund of the product complies with “Consumer’s protection law” noticed by Economic Planning Dept.
- Warranty period is 1 year (Two years in Europe).
- We will repair or replace any part of the FC1400 found to be defective in usual operating circumstance for free to you.
- This warranty does not apply to any defect caused by improper abuse, misuse or exposure to poor management.

Warning



Federal law restricts this device to sale by or on the order of a physician

Contact Bionet

If you have any questions or comments relating to our products or purchasing, please contact the telephone numbers or E-mail below. You can talk to our salespeople. Bionet always welcomes your enquiries. Please contact us.

**Headquarter &
International
Sales & service****Bionet Co., Ltd. :**

5F, 61 Digital-ro 31 gil, Guro-gu, SEOUL
08375, REPUBLIC OF KOREA
Tel : +82-2-6292-6410 / Fax : +82-2-6499-7789
e-mail : sales@ebionet.com
Website: www.ebionet.com

**U.S.A
sales & service
representative****Bionet America, Inc. :**

2691, Dow Ave, Suite B
Tustin, CA 92780 U.S.A.
Toll Free : 1-877-924-6638 / FAX : 1-714-734-1761
e-mail: support@bionetus.com
Website : www.bionetus.com

**European
sales & service
representative****CMC Medical Devices & Drugs S.L. :**

C/ Horacio Lengo Nº 18, CP 29006, Málaga, Spain
Tel +34-951-214-054 / Fax +34-952-330-100
E-mail: info@cmcmmedicaldevices.com
Website: www.cmcmmedicaldevices.com

※ In the event of a malfunction or failure, contact Service Dept. Of Bionet Co., Ltd. along with the model name, serial number, date of purchase and explanation of failure.

Charged service

If you request for any non-warranty service, including checking the unit when there is no problem present, you will be charged accordingly. Therefore, please be sure to read this user manual.

<ul style="list-style-type: none"> - Use instructions and simple checking without disassembly - Reinstallation due to improper installation by a seller 	<p>Charged beginning the second time The service provided the first time shall be free of charge.</p>
<ul style="list-style-type: none"> - Improper installation due to any movement of the product or any movement of the user's office - Reinstallation after installation at the time of purchase as requested by the customer - Reinstallation due to improper installation by the consumer - Any and all services requested due to any foreign material put into the product or improper cleaning or abuse. 	<p>Charged the first time</p>

1. Product cleaning, adjustments, use instructions, etc., are not product troubles.

(If the product cannot be repaired, separate criteria shall apply.)

2. In case of trouble due to any fault of the consumer

When a problem has been caused by the consumer's careless handling or incorrect repair

- When a problem has been caused by the use of incorrect electric capacity
- When problem or damage has been caused by dropping
- When a problem has been caused by the use of consumables or accessories other than those designated by the company
- When a problem has been caused by repair performed by persons other than an engineer from Bionet Co., Ltd. or from any agency authorized by Bionet Co., Ltd.

3. Other cases

- When a problem has been caused by a natural disaster (fire, damage by salt, damage by water, earthquake, etc.)
- When the lifetime of a consumable part (accessory) has ended

Table of Contents

<u>CHAPTER 1. BASICS</u>	8
<u>DEFINITION OF WARNING, PROHIBITION, MANDATORY ACTION, AND, NOTE</u>	8
<u>GENERAL PRECAUTION ON ENVIRONMENT</u>	9
<u>GENERAL PRECAUTION ON ELECTRIC SAFETY</u>	13
<u>SAFETY SYMBOLS</u>	18
<u>CHAPTER 2. INSTALLATION</u>	19
<u>1) OVERVIEW OF THE PRODUCT</u>	19
<u>2) CHARACTERISTICS OF THE PRODUCT</u>	19
<u>3) COMPOSITION OF THE PRODUCT</u>	20
<u>4) COMPOSITION OF FC1400</u>	22
<u>5) SYSTEM INSTALLATION</u>	25
<u>CHAPTER 3. BASIC OPERATION</u>	28
<u>1) SYSTEM START</u>	28
<u>2) SYSTEM FINISHING</u>	28
<u>3) GRAPHIC SCREEN</u>	28
<u>4) OPERATION PANEL</u>	29
<u>5) MENU</u>	30
<u>6) POWER CONNECTION</u>	32
<u>7) OPERATING MODES</u>	35
<u>CHAPTER 4. PATIENT & DATA MANAGEMENT</u>	36
<u>1) PATIENT REGISTRATION</u>	36
<u>2) EDIT PATIENT INFORMATION</u>	38
<u>CHAPTER 5. FHR MEASUREMENT USING US</u>	39
<u>1) FHR MEASUREMENT</u>	39
<u>2) US SCREEN</u>	41
<u>3) SETUP</u>	41
<u>CHAPTER 6. EXTERNAL MEASUREMENT OF UTERINE CONTRACTION</u>	44
<u>1) UC MEASUREMENT</u>	44
<u>2) TOCO SCREEN</u>	46
<u>3) SETUP</u>	46
<u>CHAPTER 7. FETAL MOVEMENT MEASUREMENT</u>	48
<u>CHAPTER 8. STIMULATOR</u>	50

<u>CHAPTER 9. CLINICAL MARK AND NOTE</u>	51
<u>CHAPTER 10. TRACE</u>	53
<u>1) TRACE AREA</u>	53
<u>2) TRACE</u>	54
<u>3) SETTING UP TRACE MODES</u>	55
<u>CHAPTER 11. PRINT</u>	57
<u>1) PRINTING IN REAL TIME</u>	57
<u>2) TREND PRINTING</u>	58
<u>3) PAPER REPLACEMENT</u>	58
<u>4) HOSPITAL NAME</u>	59
<u>CHAPTER 12. ALARM AND PRESET</u>	60
<u>1) PATIENT CONDITION ALARM</u>	60
<u>2) PRODUCT CONDITION ALARM</u>	60
<u>3) VISUAL ALARM</u>	61
<u>4) ALARM LED</u>	61
<u>5) AUDIBLE SILENCE AND PAUSE</u>	61
<u>6) ALARM LATCHING</u>	62
<u>7) ALARM HISTORY</u>	62
<u>8) PRESET</u>	63
<u>9) ALARM VOLUME ADJUSTMENT</u>	64
<u>10) SETTING ALL ALARMS ON/OFF</u>	65
<u>11) SETTING ALL ALARMS RANGES</u>	65
<u>12) SETTING ALL ALARM LEVELS</u>	66
<u>13) DEFAULT SETTING</u>	66
<u>14) SIGNAL LOSS ALARM</u>	66
<u>CHAPTER 13. NETWORK</u>	67
<u>CHAPTER 14. GENERAL SETTING</u>	69
<u>1) DATE CHANGING</u>	69
<u>2) TIME CHANGING</u>	69
<u>3) LANGUAGE CHANGING</u>	69
<u>4) VERSION INFORMATION</u>	70
<u>5) CHANGING THE TOUCH VOLUME</u>	70
<u>6) DEMO OPERATION</u>	70
<u>7) EDIT NOTE</u>	70
<u>8) MARKER SOUND</u>	71
<u>9) FACTORY</u>	71
<u>10) CHANGE ADMIN PW</u>	71
<u>11) VOLUME RANGE</u>	71
<u>12) CHANGING THE SCREEN OUTPUT MODE</u>	71

13) PROTOCOL VERSION	71
CHAPTER 15. NST	72
1) NST MEASUREMENT	72
2) NST SETTING	72
CHAPTER 16. CTG TERMS	73
1) SETTING	73
2) CTG OUTPUT	73
3) CTG MEASUREMENT RESULTS	74
4) GLOSSARY OF CTG TERMS	75
5) ACCELERATION	76
6) LATE DECELERATION	77
7) EARLY DECELERATION	78
8) VARIABLE DECELERATION	79
CHAPTER 17. MESSAGE LIST	80
CHAPTER 18. SIMPLE TROUBLESHOOTING	81
1) TROUBLESHOOTING AND SOLUTIONS	81
2) PERFORMING PERIODIC INSPECTIONS	81
CHAPTER 19. PRODUCT SPECIFICATION	82
APPENDIX A. MANUFACTURER'S DECLARATION - ELECTROMAGNETIC IMMUNITY	84
APPENDIX B. MAINTENANCE, CARE, AND SERVICE	89
APPENDIX C. ULTRASOUND POWER	91
APPENDIX D. ABBREVIATION AND SYMBOL	94

Chapter 1. Basics

Definition of Warning, Prohibition, Mandatory Action, and Note

For special emphasis on agreement, terms are defined as listed below in user's manual. Users should operate the equipment according to all the warnings and cautions.

Warning	
	To inform that it may cause serious injury or death to the patient, property damage, material losses.











Caution	
	To inform that it may cause no harm in life but lead to injury.

Mandatory Action	
	To inform that it must be done for safe operation and maintenance of the equipment.

Note	
	To inform that it is not dangerous but important "note" sign for proper installation, operation, and maintenance of the equipment.

General Precaution on Environment

Do not keep or operate the equipment in the environment listed below.

	<p>Avoid placing in an area exposed to moisture. Do not touch the equipment with wet hands.</p>		<p>Avoid exposure to direct sunlight</p>
	<p>Avoid placing in an area where there is a high variation of temperature. Operating temperature ranges from 10°C to 40°C. Operating humidity ranges from 30% to 85%.</p>		<p>Avoid placing in the vicinity of Electric heaters</p>
	<p>Avoid placing in an area where there is an excessive humidity rises or ventilation problem.</p>		<p>Avoid placing in an area where there is an excessive shock or vibration.</p>
	<p>Avoid placing in an area where chemicals are stored or where there is danger of gas leakage.</p>		<p>Avoid inserting dust and especially metal material into the equipment</p>
	<p>Do not disjoint or disassemble the equipment. We take no responsibility for it.</p>		<p>Power off when the equipment is not fully installed. Otherwise, equipment could be damaged.</p>

CAUTIONS

Before Installation

Compatibility is critical to safe and effective use of this device. Please contact your local sales or service representative prior to installation to verify equipment compatibility.

Defibrillator Precaution

Patient signal inputs labeled with the CF and BF symbols with paddles are protected against damage resulting from defibrillation voltages. To ensure proper defibrillator protection, use only the recommended cables and lead wires.

Proper placement of defibrillator paddles in relation to the electrodes is required to ensure successful defibrillation.

Disposables

Disposable devices are intended for single use only. They should not be reused as performance could degrade or contamination could occur.

Disposal of your old appliance



1. When this crossed out wheeled bin symbol is attached to a product it means the product is covered by the European Directive 2002/96/EC.
2. All electrical and electronic products should be disposed of separately from the municipal waste stream via designated collection facilities appointed by the government or the local authorities.
3. The correct disposal of your old appliance will help prevent potential negative consequences for the environment and human health.
4. For more detailed information about disposal of your old appliance, please contact your city office, waste disposal service or the shop where you purchased the product.

WARNING

This product contains a chemical known to the State of California to cause cancer, birth defects, or other reproductive harm.

Electrocute Precautions

To prevent skin burns, apply electrocute electrodes as far as possible from all other electrodes, a distance of at 15 cm/6 in. is recommended.

EMC

Magnetic and electrical fields are capable of interfering with the proper performance of the device. For this reason make sure that all external devices operated in the vicinity of the monitor comply with the relevant EMC requirements. X-ray equipment or MRI devices are possible source of interference as they may emit higher levels of electromagnetic radiation.

Also, keep cellular phones to other telecommunication equipment away from the monitor.

CAUTIONS

Instruction for Use

For continued safe use of this equipment, it is necessary that the instructions are followed. However, instructions listed in this manual in no way supersede established medical practices concerning patient care.

Loss of Data

Should the monitor at any time temporarily lose patient data, the potential exists that active monitoring is not being done. Close patient observation or alternate monitoring devices should be used until monitor function is restored.

If the monitor does not automatically resume operation within 60 seconds, power cycle the monitor using the power on/off switch. Once monitoring is restored, you should verify correct monitoring state and alarm function.

Maintenance

Regular preventive maintenance should be carried out annually (Technical inspections). You are responsible for any requirements specific to your country.

MPSO

The use of a multiple portable socket outlet (MPSO) for a system will result in an enclosure leakage current equal to the sum of all individual earth leakage currents of the system if there is an interruption of the MPSO protective ground conductor. Do not use an additional extension cable with the MPSO as it will increase the chance of the single protective ground conductor interruption.

Negligence

BIONET does not assume responsibility for damage to the equipment caused by improperly vented cabinets, improper or faulty power, or insufficient wall strength to support equipment mounted on such walls.

NOTES

Power Requirements

Before connecting the device to the power line, check the voltage and frequency. Ratings of the power line are the same as those indicated on the unit's label. If this is not the case, do not connect the system to the power line until you adjust the unit to match the power source.

In U.S.A, if the installation of this equipment will use 240V rather than 120V, the source must be a center-tapped, 240V, single-phase circuit.

Restricted Sale

U.S.A federal law restricts this device to sale by or on the order of a physician.

Supervised Use

This equipment is intended for use under the direct supervision of a licensed health care practitioner.

Ventilation Requirements

Set up the device in a location which affords sufficient ventilation. The ventilation openings of the device must not be obstructed. The ambient conditions specified in the technical specifications must be ensured at all times.

- Put the monitor in a location where you can easily see the screen and access the operating controls.
- This product is protected against the effects of cardiac defibrillator discharges to ensure proper recovery, as required by test standards (The screen may blank during a defibrillator discharge but recovers within a second as required by the test standards).

General Precaution on Electric Safety

Check the items listed below before operating the equipment.

- Be sure that power supply line is appropriate to use. (100~240V AC)
- Be sure that the entire connection cable of the system is properly and firmly fixed.
- Be sure that the equipment is completely grounded. (If not, this might cause problems to occur in the product.)
- Is there any damage - which may affect the monitoring or safety of the patient — to any of the equipment or accessories?

NOTE

The equipment should not be placed in the vicinity of electric generator, X-ray, broadcasting apparatus to eliminate electric noise during operation. Otherwise, it may cause incorrect results. Isolated power line is important for FC1400 To use same power source with other electric instruments may cause incorrect results.

NOTE

FC1400 is classified as listed below:

- Do not use the equipment in the vicinity of flammable anesthetics and solvents.
- The monitor is designed to fulfill safety requirements according to IEC 601-1/EN 60601-1 (Class I), Degree of protection against electrical shock type-BF.

NOTE

In hospitals, doctors and patients are exposed to the danger of uncontrollable electric currents. These electric currents are generated by potential differences between the equipment and conductive objects that may come into contact with the equipment. Please make sure that the auxiliary equipment connected to the equipment to solve this problem satisfies EN60601-1-1:1996.

Warning



Avoid contact with the patient during any defibrillation (may result in serious injury or death). To avoid the danger of serious electric burning, shock, or injury, everybody should stay away from the bed and should refrain from touching any equipment connected to the patient.

FC1400 Operation Manual

NOTE

This equipment must only be connected to a supply mains with protective ground.

NOTE

Avoid contact with the connector pin of the equipment and the patient at the same time while the equipment is in use.

Do not connect or remove the power cable with wet hands.

NOTE

In case the medical equipment does not operate normally, or if it has been damaged, do not use it on any patient; instead, contact the medical equipment engineer in your hospital or the equipment supplier.

Warning



Devices for fetal heartbeat sound measurements using ultrasonic (US) waves or uterine contraction measurements (TOCO) performed from outside of the uterus are not designed for use during any electric operation, defibrillation, or defibrillator discharge.

Warning



The equipment has not been designed for use with other types of monitoring equipment apart from those devices permitted for use together with the equipment in this manual.

Warning



Do not touch signal input, signal output or other connectors, and the patient simultaneously.

Warning



ELECTROSURGERY - The monitor is not designed for use with high-frequency surgical devices. In addition, measurements may be affected in the presence of strong electromagnetic sources such as electrosurgery equipment.

Biocompatibility

When used as intended, the parts of the product described in this operator manual, including accessories that come in contact with the patient during the intended use, fulfill the biocompatibility requirements of the applicable standards. If you have questions about this matter, please contact BIONET or its representatives.

Maintenance and Washing Equipment Connection

Although FC1400 and its accessories can be cleaned in many ways, please use the methods recommended below to avoid unnecessary damage to or contamination of the equipment.

If any dangerous material other than those designated for cleaning has been used, the resulting contaminated or damaged equipment will not be repaired free of charge even during the warranty period.

Make sure that the monitor, probe, cable, and accessories are free of sand or dust. Carefully check the equipment after each cleaning or disinfection. If degeneration or damage has been found, do not use the equipment.

Please take note of the following:

- Be sure not to leave any cleaning/disinfecting chemical residue on the surface of the equipment. After allowing sufficient time for the chemical to work, wipe off all residues with a cloth damp with water.
- Prevent any fluid from seeping into the monitor, module, or accessories.
- The monitor, module, or accessories should not be soaked in any fluid; protect them from water drops or prevent water from being splashed on them.
- Never use any abrasive material (steel wool or silver polish).
- Never use any bleaching agent.
- Do not use any kind of drying equipment such as heater, oven (including microwave oven), hair dryer, or heating lamp.

NOTE

After cleaning the equipment, carefully check the main body and the probe.

Component cleaning Electric cable and lead wire

NOTE

- Do not use acetone or ketone solvents for cleaning
- Do not use an autoclave or steam cleaner.
- Do not mix the cleaner with any disinfecting solution (toxic gases may be produced).
- Please turn off the power before cleaning; do not pour water into the item being cleaned

FC1400 Operation Manual

Electric cables and lead wires can be wiped off or cleaned with towels wet with lukewarm water, neutral soap, or isopropyl alcohol. Using ethylene oxide for intensive disinfection (almost complete sterilization) is allowed. Note, however, that it will reduce the lifetime of cables or lead wires. Clean the belt using soap and water while making sure that the water temperature does not exceed 60°C.

NOTE

The decision to sterilize must be made per your institution's requirements with an awareness of the effect on the integrity of the cable or lead wires.

NOTE

The Equipment needs safety inspection once a year. Please refer to user's guide or service manual.

After cleaning the equipment, carefully inspect the main body and the sensors. Do not use the equipment if it has been damaged or if it has deteriorated.

Clean the exterior of the equipment at least once a month using soft cloth wet with tepid water or alcohol. Do not use lacquer, thinner, ethylene, or any oxidizing agent that may cause damage to the equipment. After verifying that there is no dust or contamination on the cables and accessories, wipe them off with soft cloth wet with 40°C/104°F water. Wipe them at least once a week using clinical alcohol.

NOTE

There is back-up battery on board inside system. Please dispose of according to all local regulations.

Warning



Remove AC power before changing battery.
Check the electrodes of batteries before changing them.

If the installation or arrangement of the external grounding wire is doubtful, operate the equipment with internal power.





In case the equipment is not to be used for some time, remove the primary battery if no safety problem is expected to occur.

NOTE

Annual Servicing – For continued safety and performance of the monitor, it is recommended that the calibration, accuracy, and electrical safety of the monitor be verified on an annual basis by a Bionet Service Representative.













Daily Testing – It is essential that the monitor and accessories be inspected every day. It is recommended practice to initiate the monitor's self-test feature at the beginning of each monitoring session; follow the instructions in Chapter 1,2.

Safety Symbols Marked on the Package

Symbols	Contents
	Show the direction of top
	Keep dry
	fragile
	Not to use hook

Safety Symbols

The International Electro technical Commission (IEC) has established a set of symbols for medical electronic equipment which classify a connection or warn of any potential hazards. The classifications and symbols are shown below.

Symbols	contents
	Defibrillation proof type CF applied part (IEC 601-1)
	External Signal IN/OUT Port
	IEC 60601-1 Type BF applied part
	Stand by
	External Signal Ethernet Port
	External Signal USB Port
	IEC 60601-1 Type CF applied part
	Equipotentiality
	Video Out
IPX0, IPX1 and IPX7	Protection against vertically falling water drops(IEC 60529) Water Protection Specification Level 0, Level 1 and Level 7
	Follow operating instructions (IEC 60878 Safety)
	Consult accompanying documents
	This symbol indicates that waste electrical and electronic equipment must not be disposed of as unsorted municipal waste and must be collected separately.

Chapter 2. Installation

1) Overview of the product

FC1400 is a fetal monitoring device used to measure Fetal Heart Rates (FHR), degree of maternal uterine contraction (UA: Uterine Activity), and fetal movements (FM). FC1400 projects ultrasounds into the abdomen of the patient. From the signals returned after being reflected by the heart of the fetal, FC1400 extracts Doppler frequencies that vary with the movements of the heart of the fetal to output changes in the heartbeats of the fetal as sounds for the analysis of the signals; thus detecting the heart rates and fetal movements of the fetal. In addition, it detects the degrees of uterine contraction of patient using a pressure sensor. It indicates the fetal heart rates, maternal uterine activity, and fetal movements on its LCD screen as figures and saves the information to its memory.

2) Characteristics of the product

1. The product measures fetal heart rates and fetal movements simultaneously.
2. By using the US probe for twin fetal, twin fetal' FHR and fetal movements can be measured. (optional specification)
3. Measured data can be saved and identified on the LCD. Thus, the condition of the fetal can be efficiently monitored during labor without wasting recording sheets.
4. While reviewing the saved data, any data that should be kept in recording sheets can be printed at high speeds.
5. With ultrasound Doppler probes having high durability even against noise, clear sounds of the heartbeats of the fetal and accurate FHR of the fetal can be detected.
6. Its ultrasound irradiation radius was remarkably increased using 7-crystal, 1MHz to minimize broken FHR waveforms even if the fetal or the patient moves.
7. Since new design concepts have been applied, Tilt is mechanically possible. Thus, the product can be used conveniently anywhere.
8. Universal communication interfaces including LAN are provided for connection with the central parturition monitoring system.
9. Rechargeable batteries are used; thus, parturition conditions can be continuously monitored even during a power failure. (optional specification)

Warning



Using accessories other than those supplied by the company or non-standard ones may cause signal distortions or noise. Be sure to use only standard accessories supplied by the company.

3) Composition of the product

The Fetal system has the following components (please open the package box and check if the following components are included; in addition, please check the main body and the components for any damage):

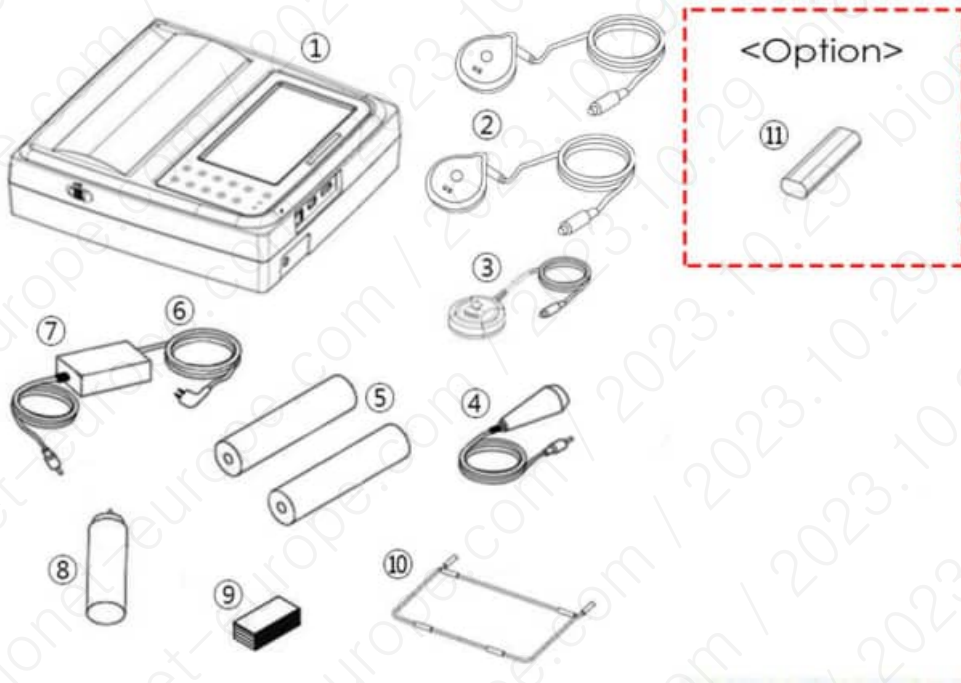

Basic composition and accessories

- ① Fetal system main body
- ② US probes (2)
- ③ TOCO probe (1)
- ④ Marker for patient (1)
- ⑤ Recording sheet (2)
- ⑥ Power cord (1)
- ⑦ Adaptor (1)
- ⑧ Ultrasonic gel (1)
- ⑨ Fixing belt (3)
- ⑩ FC1400 Stand (1)

Optional specification

- ⑪ Battery (1)

FC1400 Operation Manual

Warning



Do not reuse the ultrasonic gel.

Warning



How to replace battery: Please make sure you use the right battery as shown here. Otherwise, we are not liable for any damages and/or explosion caused by the wrong battery.



Lithium-ion battery
(10.8V / 3250mAh)



Ni-MH Battery
(12V / 2600mAh)

Warning



Do not subject the probe to physical shocks or excessive pressure.
Shock and excessive pressure on the probe may damage the internal sensor.
Impact or excessive pressure on the center of the probe may cause damage.



4) Composition of FC1400

▣ Top view

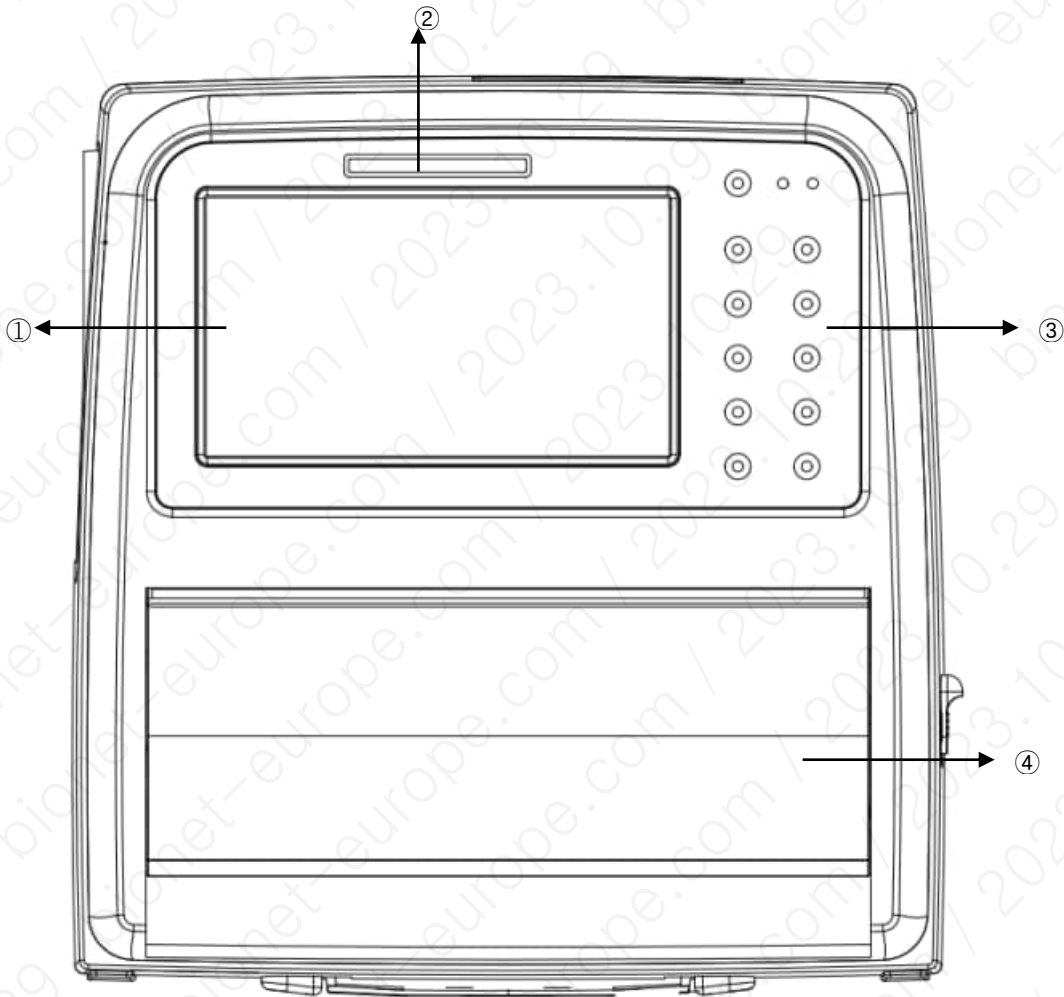

- ① Graphic display window: Part that displays the contents of measurements and condition of the equipment
- ② Alarm LED : Part that displays the status of alarm
- ③ Control panel : Controls the functions
- ④ Printer door : Opens for replacing recording paper

Warning



To avoid high-voltage electric shock, please refrain from disassembling the equipment. If any of the probes has been damaged, please stop using it to prevent electric shock and contact our company's service center or agency for the replacement of the probe. Disassembly, etc., may be performed only by those who are qualified to provide service for our products.

FC1400 Operation Manual

▣ Front view

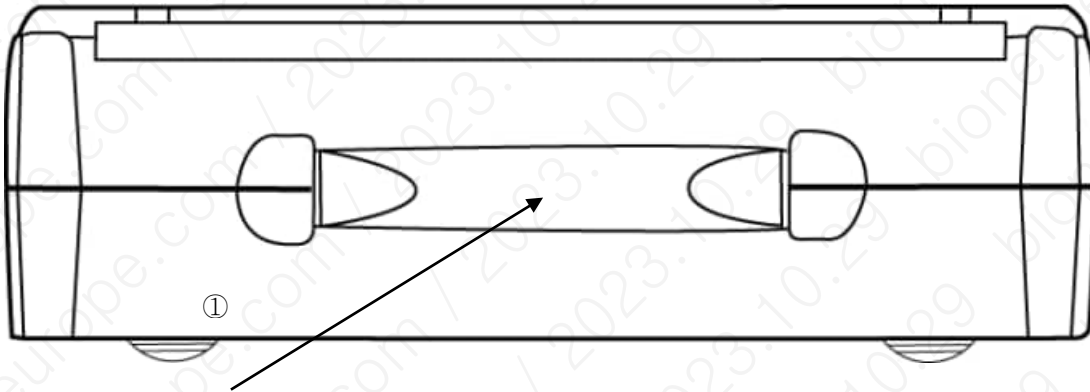

① Hand Grip : Use when lifting and moving the equipment

▣ Rear view

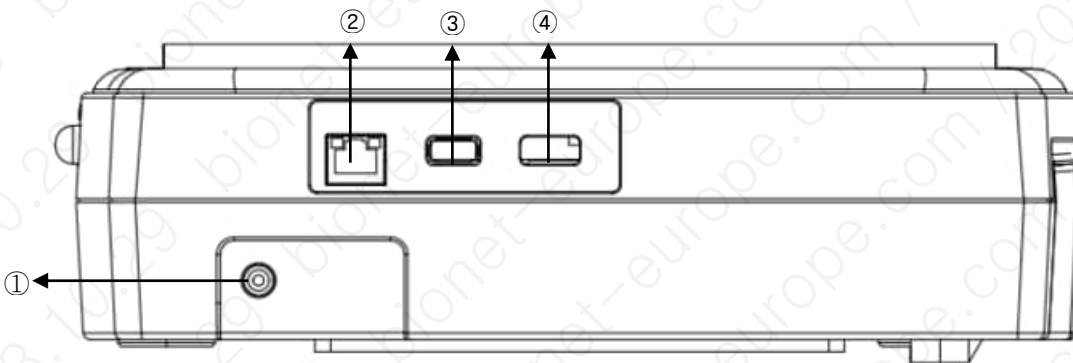

① Power adaptor connector: Power adaptor of 18V, 2.8 A is connected

② LAN Port: Part for LAN communications with external equipment

③ USB1 Port: Part for USB1 communications with external equipment

④ USB2 Port: Part for USB2 communications with external equipment

Mandatory Action



DO NOT REMOVE the USB device until it recognized completely.

FC1400 Operation Manual

▣ Right side view

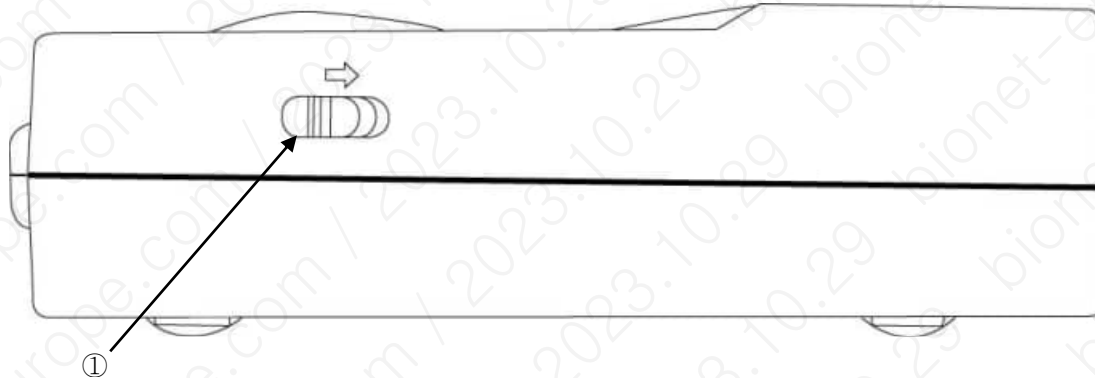

① Printer door release lever: Slide lever to open printer door

▣ Left side view

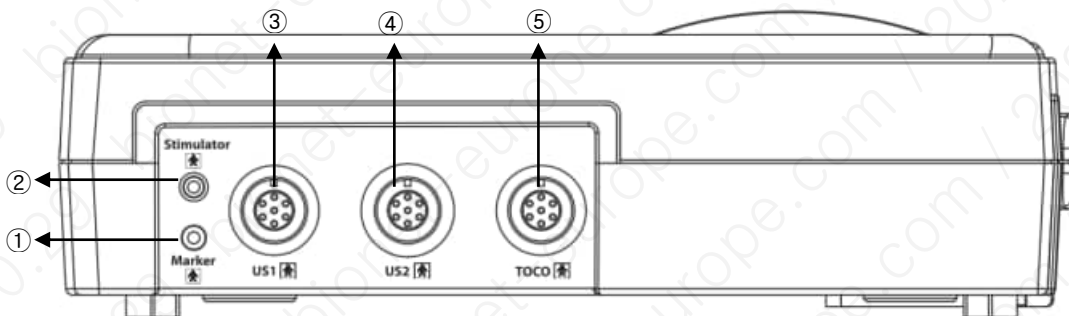

- ① Marker jack connection terminal: Terminal to which the marker jack cable is to be connected
- ② Stimulator jack connection terminal : Terminal to which the stimulator cable is to be connected.
- ③ US probe connection terminal 1: Connection terminal to which the US probe is to be connected
- ④ US probe connection terminal 2: Connection terminal to which the US probe is to be connected when measuring twin fetal
- ⑤ TOCO probe connection terminal: Connection terminal to which the TOCO probe is to be connected

Prohibition



Please instruct the operators to avoid contact with both the USB or LAN port area and the patient simultaneously.

RISK OF ELECTRICAL SHOCKS – DO NOT OPEN THE DEVICE : Device disassembly is only authorized to individuals with Bionet service authorization.

5) System installation

▣ Cautions in installation

Preparations before use

- Be sure to use this equipment in dry condition at normal temperatures (temperature: 10 ~ 40°C, humidity: 30 ~ 85%).
- Be sure to use an outlet away from any equipment that may generate electric noise (room heating/cooling equipment using a large motor, etc.).
- Installation of recording paper: You can open printer cover by pushing "Printer cover open" lever to the right. Load paper with printable side up and close the cover
- Put the adaptor into the connection site at the back of the main body to connect power to the equipment. At this time, please check if the Power Cord has been installed properly.

Storage Temperature : -10~+60°C(-29°F~+15°F)
Storage Pressure : 50(500)~106Kpa(1060mbar)
Storage Humidity Humidity: 20~95%(without condensation)

FC1400 stand installation (Option)

- Insert the FC1400 stand to the stand hole on the underside of the FC1400

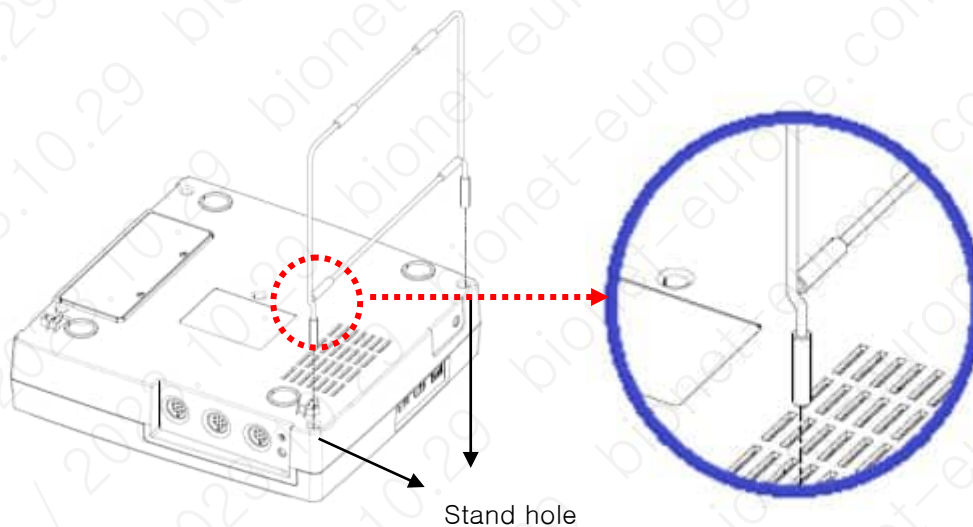

Operating procedure

- Turn on power to the equipment. Power will be turned on if the power switch on the front side of the main body is pressed for two seconds when power has been turned off; on the other hand, power will be turned off if the power switch is pressed for two seconds when power has been turned on.
- Put some ultrasound gel on US probe, find heartbeat of fetal and fix it around the abdomen of pregnant woman using a fixing belt.
- Fix TOCO probe on Fundus which is located 10 cm above the belly button of the maternal abdomen using a fixing belt.
- Determine a use mode and use the equipment accordingly.

How to store and manage the equipment after use

- Turn off the power switch and unplug the power cord.
- When the operation has been completed, clean the equipment and accessories to prevent malfunction.

Cautions in use

Installation and storage

- Please avoid moisture, high temperature, dust in the air, salt, and sulfuric materials including places that are not well-ventilated and direct sunlight.
- Please avoid vibrations or mechanical impacts.
- Please avoid places where chemicals are stored, or gases are generated.
- The equipment should operate at the indicated voltage and frequency.

Before operation

- The equipment should be properly grounded.
- Please connect all cords accurately and safely.
- When using an optional battery, please charge it for at least four hours.
- Any area directly connected to the patient should be double-checked.
- Please use the equipment within the range of operating temperatures.

During operation

- The patient should not come into contact with any metal areas of the equipment such as sash or case. The operator should not touch the patient and the equipment simultaneously.
- If any abnormality has been found, turn off power and unplug the power cord.
- Do not use any sharp or pointed object when pressing the LCD or any touch key.
- Do not confuse demo data with patient data.

FC1400 Operation Manual

After use

- Turn off the power switch and unplug the power cord.
- Take off the probes connected to the patient.
- Once the operation has been completed, clean the equipment and accessories to prevent malfunction.

Periodic checking

- Please keep the main body and the measuring probe clean by wiping them off with soft cloth wet with alcohol at least once a month. Do not use lacquer, thinner, ethylene, or oxidizing substances.
- Keep the cables free of dust or dirt. Wipe off the cables with cloth wet with tepid water (40°C/104°F) after use and wipe them off with clinical alcohol at least once a week.
- Please periodically check this equipment once a year.
- The equipment should be serviced only by designated specialized engineers.

Chapter 3. Basic operation

1) System start

Press the power switch on the main body for two seconds; power will then be turned on, with the company name displayed for around five seconds followed by the home screen.

2) System finishing

Holding the power switch for 3 seconds will turn off. Holding the power button of the device for more than 6 seconds will trigger power off action.

3) Graphic screen

▣ Monitoring screen

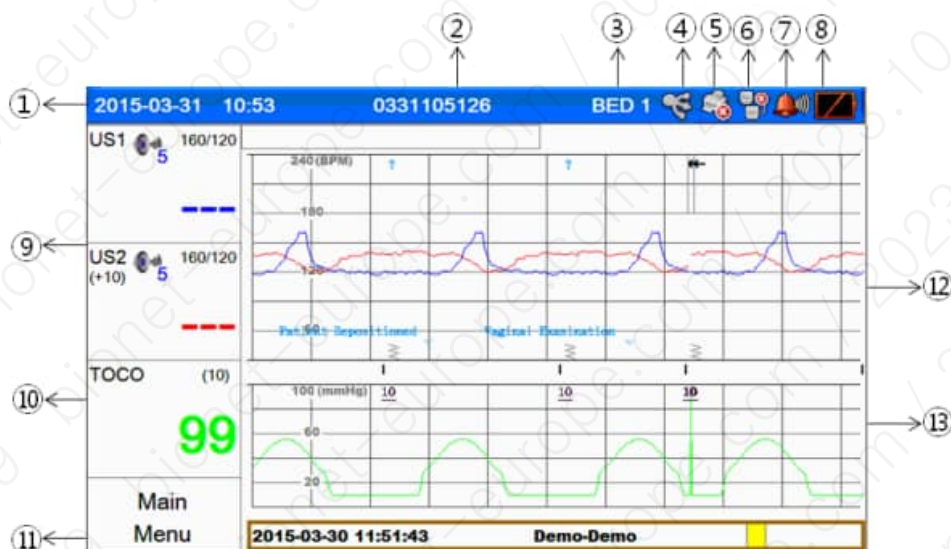

- ① Date and time
- ② Patient name or ID
- ③ Bed ID
- ④ Icon indicating the state of connection of the USB terminal
- ⑤ Icon indicating the state of printing
- ⑥ Icon indicating the state of connection of the network
- ⑦ Icon indicating the state of alarm sound and volume of Alarms
- ⑧ Icon indicating the residual battery capacity
- ⑨ Parameter window of fetal heart rates
- ⑩ Parameter window of Uterine contraction
- ⑪ Main menu
- ⑫ Window displaying the trends of fetal heart rates
- ⑬ Window displaying the trends in the degrees of uterine contraction, fetal movements

4) Operation panel

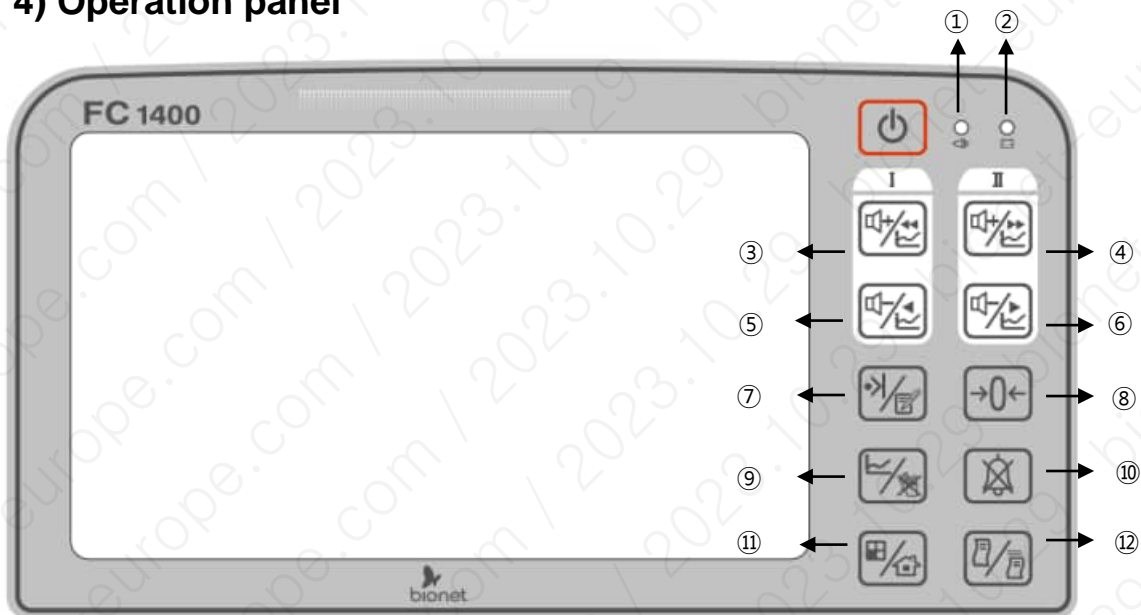

- ① AC power input LED: LED indicating the state of AC power connections
- ② Battery operation LED: LED indicating the state of battery charges
- ③ US1 volume up button
Short key : US1 Volume up or moving to earlier 1 min in trace mode
Long key : Return US1 volume back to the Pre-Mute stage.
- ④ US2 volume up button
Short key : US2 Volume up or moving to later 1 min in trace mode
Long key : Return US2 volume back to the Pre-Mute stage.
- ⑤ US1 volume down button
Short key : US1 Volume down or moving to earlier 6 Secs in trace mode
Long key : Mute US1 sound
- ⑥ US2 volume down button
Short key : US2 Volume down or moving to later 6 Secs in trace mode
Long key : Mute US2 sound
- ⑦ Clinical Mark and Note button:
Short key : Clinical Mark . To be used by user to record clinical mark.
Long key : To be used by user to record clinical note
- ⑧ Adjustment of zero point of the degree of uterine contraction
Attach the TOCO probe on the abdomen of the patient and press the zero-point adjusting button to set the reference value.
- ⑨ Trace button:
Short key: This is used to view trace data.
Long key: Enable or disable the screen touch lock.
- ⑩ Alarm silence key : This is used to change alarm status : silence, pause, alarm off, alarm on.

⑪ Home and function key: General screens and large value screens can be swapped; the function of a home key to move from a sub-menu to the main screen can be executed.

⑫ Printing start/stop key and Paper feeding key

Short key :

A. This is used to record data on the recording sheet in real time in the monitoring mode.

B. This is also used to print data on the recording sheet at high speeds in the data view mode.

Long key : Paper feeding key Used when feeding paper while printing is stopped.

5) Menu

▣ Menu selection

To go to a menu, touch the main menu or parameter window on the screen.

▣ Letter entry

To enter a letter, drag the cursor to the letter using the wheel and then touch the selection key or the screen



▣ Value entry

To enter a value, drag the cursor to the value using the wheel and then touch the selection key or the screen.

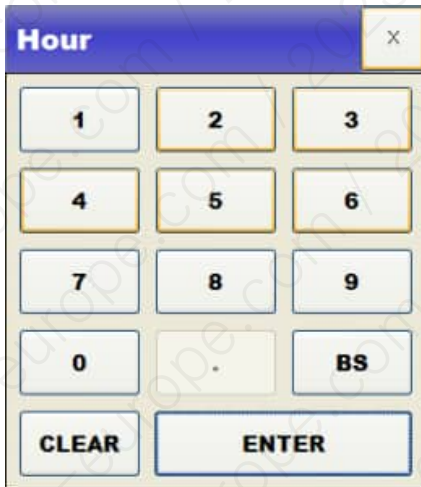

▣ Color selection and entry

To select the color of a line or a numerical value, drag the cursor to the desired color and touch the selection key or color on the screen.



▣ Line selection

To select the thickness of a line of a trend graph or a waveform to be printed, drag the cursor to the desired line thickness and touch the selection key or the line thickness on the screen.

6) Power connection

▣ AC power

If AC power is connected to the main body of the equipment, the Power LED on the front side of the equipment will emit a green light; if a battery has been installed, the power mode will be automatically changed to automatic charging mode, and the battery will be charged.

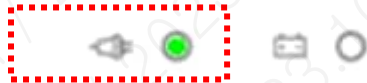

▣ Battery power

If the AC power is disconnected, and the equipment is used, power will be supplied by the battery when the power switch has been turned on and the Battery LED emits orange light. If AC power is connected to the main body of the equipment, the Power LED on the front side of the equipment will emit a green light. In case a battery has been installed, the power mode will be automatically changed to automatic charging mode, and the battery will be charged. After the battery has been fully charged, the Battery LED emits green light instead of orange.

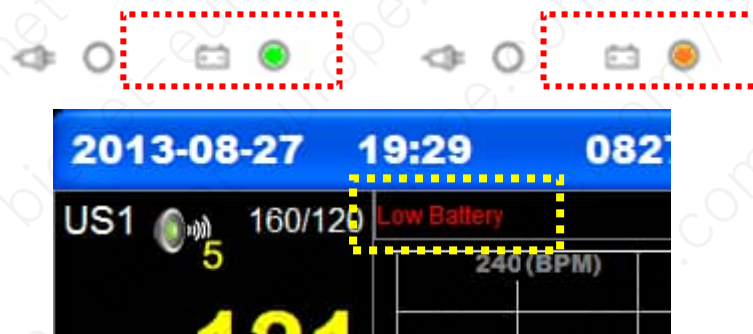

If the battery power is insufficient (8.6V or lower), alarms will sound, and "Battery low" will be displayed on the LCD screen for a few minutes before power to the equipment is automatically turned off. In this case, AC power should be immediately connected to the equipment to use it.

- Charging time: Minimum of 4 hours (Standby status)
- Continuous use time: Maximum 2 hours

▣ Changes in the screen in relation to the state of battery connection

The battery condition should be displayed in relation to connection of Battery and AC power and Battery condition as follow

* No Battery



: connect power to the equipment to use it

* Battery with little or no power



: 2 images are toggled

* Battery only



(Low),



(Medium),



(Full)

* AC and Battery



(Low),



(Medium)



(Full)

▣ Battery replacement

When the battery of this equipment is to be replaced, the same type of battery should be used.

- Type : CMICR18650 F9, Lithium-Ion Rechargeable Battery Pack
(10.8V/3250mV)
- Time: The battery will be automatically charged when the equipment is connected to AC power, and the battery cannot be charged when it is separated from the equipment. The battery can be charged at least 300 times; if using the battery for 20 minutes or longer after it is completely charged is difficult, please replace the battery with a new one. If the battery has been damaged, or battery fluid has leaked out, please replace the battery immediately. Do not use a damaged battery in the equipment.
- Method: Connect the connector as shown in the following image. (Connector cannot be plugged inversely)

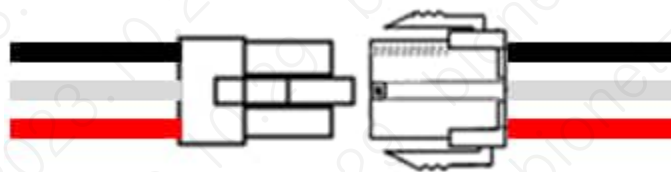

< Connect the Battery >

FC1400 Operation Manual

Warning



When replacing the battery, please pay attention to the polarity.
Plug/Unplug the Battery with the AC power removed

Warning



To protect the environment, do not carelessly dispose of wastes or residues such as the components of the equipment after its lifetime; instead, ask the biomedical engineering department of the hospital to dispose of them in the designated places following appropriate procedures.

If the installation or arrangement of the external grounding wire is doubtful, operate the equipment with internal power. In case the equipment is not to be used for some time, remove the primary battery if no safety problem is expected to occur.

▣ Effect of lithium-ion battery technology applied to the battery

Refer to the following descriptions on the lithium-ion battery technology:

Batteries will be discharged if they are not connected to a monitor. This discharge is caused by the currents required by the circuit integrated with the lithium-ion batteries. Owing to the nature of lithium batteries themselves, the batteries are self-discharged. The rate of self-discharge is doubled every time the temperature is increased by 10°C (18°F).

The loss of electric capacity retained by a battery is higher when the temperature of the battery is higher. Over the lifetime of a battery, the capacity of a completely charged battery will gradually decrease, or the battery may not be charged at all. As a result, the total capacity that can be stored and used will gradually decrease.

Inspection guideline

Check the performance of the battery every 6 months through complete charge and complete discharge in the monitoring equipment.

Storage guidelines

The battery should be stored at 20°C ~ 25°C (68°F ~ 77°F) when it is not in the monitor. When the battery is installed in the equipment and connected to AC power, the temperature of the battery is increased by around 15°C ~ 20°C (59°F ~ 68°F). This shortens the lifetime of the battery.

When installed in the equipment and connected to AC power, the battery does not supply power in general. The lifetime of the battery may be shorter than 12 months. Bionet recommends detaching the battery from the monitor for storage until the equipment is moved.

7) Operating modes

There are 3 operating modes. Some are password protected.

Monitoring mode: This is normal mode for monitoring patients. You can change elements such as alarm limits and so forth. When you discharge the patient, these elements return to their default values (preset value). Changes can be stored permanently in Configuration Mode.

Configuration mode : Password protected; this is for personnel trained in configuration tasks.

Factory mode (Service mode) : Password protected; this is for trained service personnel.

Chapter 4. Patient & data management

Basic information necessary to identify patients is saved.

1) Patient registration

This is a method of registering patients when the equipment is used as independent equipment. If the equipment is used without registering patients, patient IDs will be saved as Default values.

Patients can be registered using the “New” function if they are measured for the first time. If the records of the patients measured before are left in the Trace, the “Search” function can be used to register the patients.

< Registering a new patient >

- ① Touch “Patient” in the menu.
- ② Select “New” to register a new patient.
- ③ Enter the ID, last name, first name and gestational age of the patient and press OK.

< Default : ID, last name and first name is made by date and time >

- ④ Information on the currently registered patient will appear on the position of patient information on top of the screen.

The screenshot shows a 'New Patient' registration dialog box. It features a blue title bar with the text 'New Patient' and a close button (X). The main area contains four input fields: 'ID', 'First Name', and 'Last Name', each with a light green background. Below these is a 'Gestational-age' section with two input boxes for 'weeks' and 'days'. At the bottom of the dialog are two buttons: 'Default' and 'Admit'.

FC1400 Operation Manual

< Registering a patient using "Search" >

- ① Touch "Patient" in the menu.
- ② Select "Search" to register a patient with records left in the Trace records.
- ③ By referring to the IDs, last names, first names and gestational age shown in the Patient List, touch the patient to be registered to select said patient.
- ④ Information on the currently registered patient will appear on the position of patient information on top of the screen.

NOTE

Patients' ID can be registered using a barcode scanner. Patients' ID will be entered automatically when the user scans the barcode.

Normally barcode scanners are compatible with all products. However, because of inconsistencies in barcode scanner manufacturers implementation of input methods, you need to verify the scanner is supported by Bionet.

- Input methods supported by Bionet : International standards, USB
- Products below are tested and confirmed by Bionet for FC1400.

No	Manufacturer	Product name
1	Data Logic	DL6000
2	ZEBEX	Z-3190
3	Techscan	TSK-2000

Caution

You must read the user manual of the barcode scanner to get complete information about it. The initialization codes for various products would be included. You must run the initialization after verifying the input type.

All configurations shall comply with the requirements for medical electrical systems. (See IEC60601-1-1 or clause 16 of the 3Ed. of IEC60601-1, respectively)

2) Edit patient information

This is a method of editing patients' information.

- ① Touch "Patient" in the menu.
- ② Select "Edit" to edit a patient except ID information
- ③ Information on the currently registered patient will appear on the position of patient information on top of the screen.

NOTE

The patient information which has been entered or modified in the device do not synchronize patient information in the FC central.

NOTE

Patient list will save up to 99 people entered in the recent years.
If it goes beyond 99 patients, first patient in the list is removed.

Chapter 5. FHR measurement using US

FHRs are measured by obtaining the heartbeat sounds of the fetal using ultrasonic Doppler effects and subsequently calculating and saving the heart rate per minute in real time. Since ultrasounds are reduced considerably in the air, please apply sufficient amounts of ultrasonic gel to the surface of US probes to remove any air layer before using US probes.

This equipment adjusts the volume automatically according to the amount of input data. When no input occurs while probe is connected, the noise will increase. In the running condition of the equipment, turn on the Mute by long pressing volume down key when not measured, long press volume up key to return back to the previous setting for the measurement.

1) FHR measurement

▣ US probe connection

Please connect US probes to the “US1” and “US2” connection terminals on the left side of the equipment to use the US probes.

▣ US probe



<US Probe>

▣ Basic operations following a US probe connection

When US Probe is not connected to main body, nothing will display of FHR area. On the other hand, connection of US Probe will change display to “---” of FHR area. When a US probe has been put into the “US1” connection terminal, a numerical value will be displayed in the FHR display area, indicating that the system is ready to measure FHRs.

▣ How to measure FHRs

- ① Place a fixing belt below the waist of the patient.
- ② To remove air bubbles between the abdomen of the patient and the surface of the US probe, please apply a sufficient amount of ultrasonic gel to the US probe.

NOTE

Care should be taken not to scan over a wound or incision to avoid contamination and infection.

- ③ Feel the abdomen of the patient to find the back side of the fetal and place the US probe there. If the fetal faces laterally, please place the US probe on the position shown in the figure below.

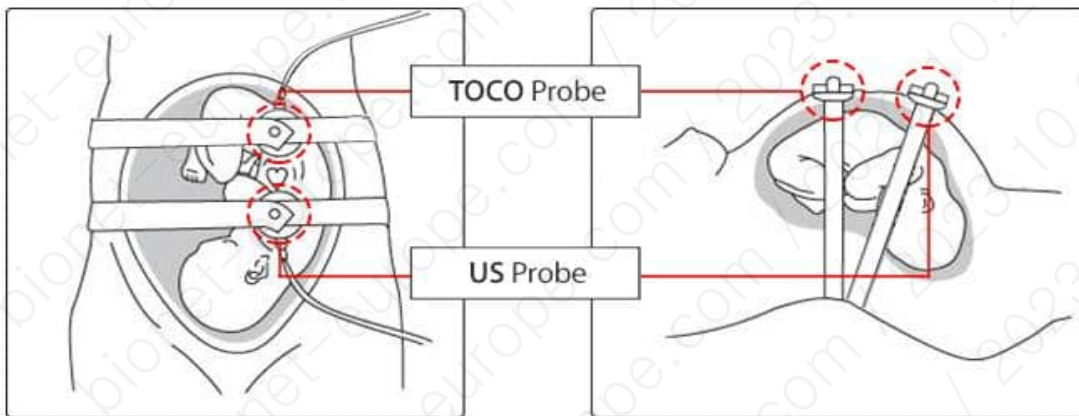

NOTE

If the US Probe is placed on the side of the chest of the fetal instead of the back side, ultrasounds will not be accurately shot to the heart of the fetal; thus, the heartbeat sounds of the fetal may be frequently missed.

- ④ Move the US probe little by little around its position to place the US probe in a position where the sounds from the heart of the fetal are heard relatively loud and clear and the heart shape in the FHR display area turns green and blinks according to the sounds from the heart of the fetal; adjust the speaker volume so that the sounds from the heart of the fetal becomes appropriately louder.
- ⑤ Put the button on the upper part of the US probe into the hole in the fixing belt to fix the US probe so that the US probe does not slip.

NOTE

If the probe cable is fixed near the head of the patient, the cable will not be damaged, and there will be relatively less movement by the probe.

It will take around 2~8 seconds for FHRs to be calculated and displayed.

2) US screen

If the US area on the screen is selected and touched, the following selection window pops up on the screen:

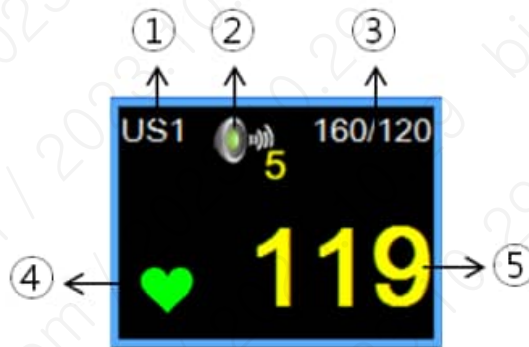

- ① Title
- ② FHR Volume Icon: This informs the user of the current state of the Volume; if this icon is touched, a volume adjusting window will be displayed.
- ③ Alarm range: This indicates the alarm ranges of parameters.
- ④ Beat indication: When FHRs are detected as beats, the heart icon will blink.
- ⑤ FHR value: This indicates the FHR values.

3) Setup

If the US area on the screen is selected and touched, the following selection window pops up on the screen (by touching the US1 area, US1-related items and common items can be set up; by touching the US2 area, US2-related items can be set up):

US1		US2	
Volume	5	Volume	5
Alarm	On	Alarm	Off
	Alarm Limit	Offset	+20
	Alarm Level	Alarm Limit	High
	Alarm Delay	Alarm Level	High
	20Sec	Alarm Delay	20Sec
Signal Loss Alarm	On	Signal Loss Alarm	On
	Color	Color	Aqua
	Yellow		

▣ FHR Sound Volume adjustment

Touch the Sound Volume menu. Select the value to be set from Off or volumes at levels 1~9.

FHR sounds can be adjusted using the operation panel or LCD screen touch the volume adjusting icon and select a volume from the popup window. And to adjust the volume of US2, touch the volume adjusting icon.

In addition, you can directly go to the Sound Volume window using the speaker icon in the US area.

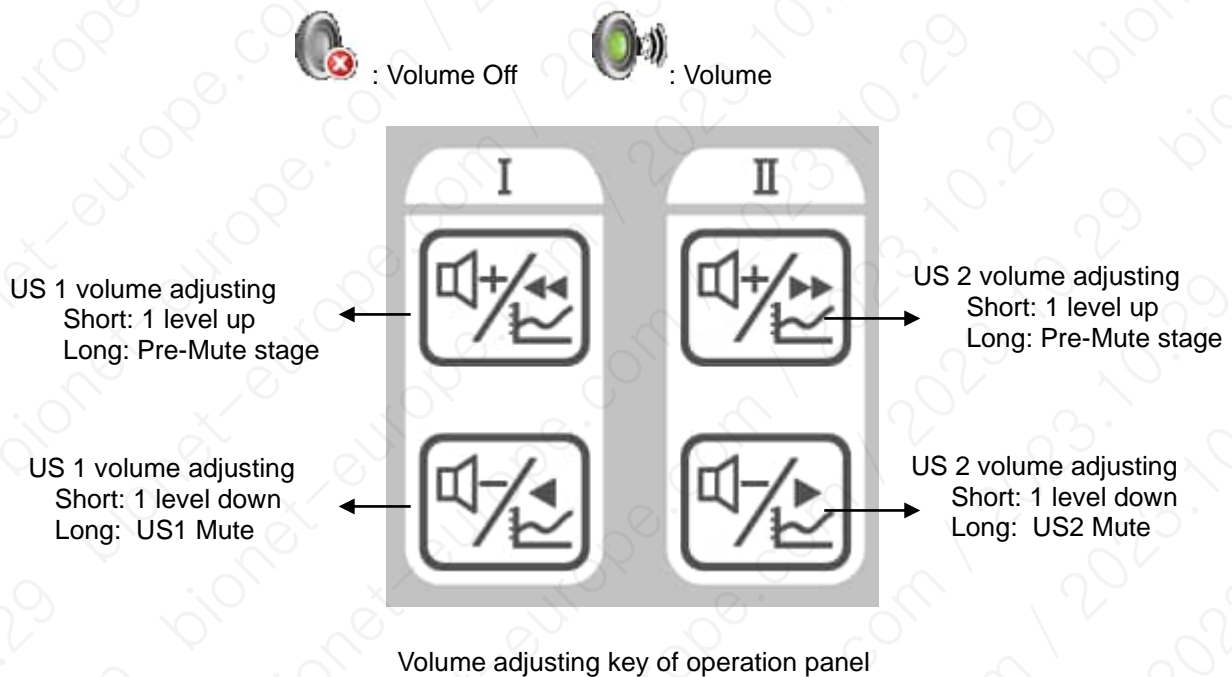

▣ Alarm

FHR alarms for US1 and US2 can be adjusted separately.
Please set up whether alarm functions for FHRs will be used.

▣ Alarm level

Set up the levels of alarms for FHRs. Patient condition alarms can be set to Medium and Low alarms.
Please refer to the alarm section in Chapter 6 for details.

▣ Alarm limit

Touch Alarm Limit section within FHR setting menu to set the alarm range of FHR.

Set by either entering numbers or touching arrow keys.

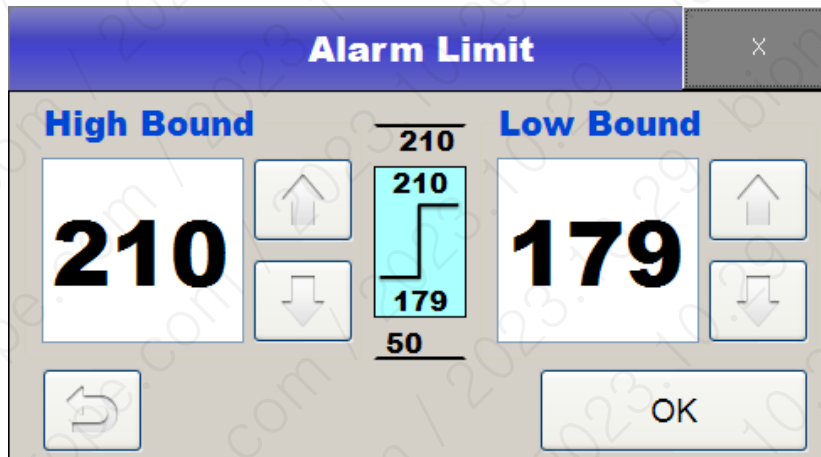

▣ Alarm delay

This is set up to prevent alarms from ringing when FHR values exceed the alarm range but only for a short time; the value is not maintained for a certain time.

To set up an alarm delay, please touch the Alarm Delay area in the FHR setting menu. If this function is not to be used, please select Off; to use this function, please select the minimum use time.

▣ Color

This is used to set up the colors of FHR values and Trace lines.

▣ Offset

This is used to display FHR2 values on the position where FHR2 Trace values and related Offset values in printing are found to identify the twin fetal' FHR values easily when they are similar to each other.

▣ Signal Loss Alarm

A fetal heart rate signal alarm occurs when the monitor lost FHR and fail to detect a decent signal.

(See 12-13)

Chapter 6. External measurement of uterine contraction

UAs are measured using external attachment-type pressure sensors. A TOCO probe is attached to the abdomen of the patient to measure the relative pressures that vary with the uterine contraction of the patient, thereby recording the uterine activity.

1) UC measurement

▣ TOCO probe connection

Please connect a TOCO probe to the "TOCO" connection terminal on the left side of the equipment.

▣ TOCO Probe



<New Probe>

▣ Basic operations following a TOCO probe connection

When no TOCO probe has been connected to the main body, "---" will be displayed in the FHR display area. When a TOCO probe has been connected to the equipment, a numerical value will be displayed, indicating that the system is ready to measure uterine activities. When FMs (Fetal Movements) are viewed, "UC+FM" will be displayed.

▣ UA measurement

- ① Place a fixing belt below the back of the patient.
- ② Place a TOCO probe on the highest peak of the abdomen of the patient (Fundus: located around 10cm above the umbilicus) or the place that hardens first in the abdomen of the patient.
- ③ Put the fixing button protruding on top of the TOCO probe into the hole of the fixing belt to fix the TOCO probe. At this time, please adjust the degree of fastening through the belt to make the TOCO value around 20 ~ 90.
- ④ Press the zero-point adjusting button to set up a reference value.

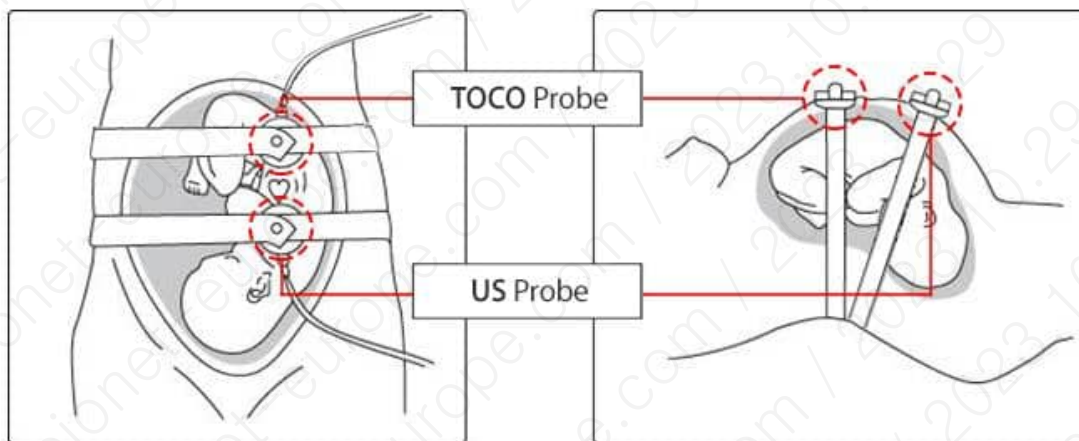

NOTE

If a TOCO probe is connected to the equipment but not used, unreliable values may appear in the TOCO display area.

2) TOCO screen

If the TOCO area on the screen is selected and touched, the following selection window pops up on the screen:

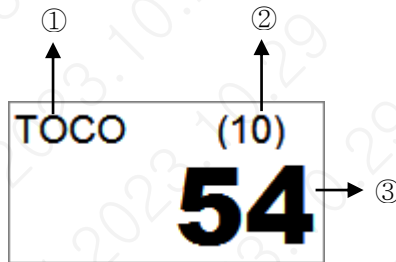

① Title

TOCO: Displays only uterine contraction but not fetal movements

TOCO+ FM: Displays both fetal movements and uterine contraction simultaneously

② TOCO Zero value: Displays the reference value that appears when Zeroing has been done

③ TOCO: Displays the degrees of uterine contraction

3) Setup

If the TOCO area of the screen is touched, the following selection window pops up on the screen:

TOCO		X
Zeroing		
Offset	10	
Auto Zeroing	Off	
Fetal Movement	FMD	
	Color	Fuchsia

▣ Zeroing

This is used to adjust the zero point of TOCO. If this is touched, the TOCO value at the moment will be set up as Offset value.

▣ Offset

This is used to set up a reference value to be used when adjusting the zero point of TOCO. One of the values 0, 10, and 20 can be selected.

Auto Zeroing

This is a function for initiating automatic adjustment of the zero point when a TOCO value is maintained below 0 for at least five seconds.

Fetal Movement

This is used to set up whether to output fetal movement-related graphs to the screen or through the printer.

If the value is "FMD+FM" or "FMD", the title of TOCO will be displayed as "TOCO+FM" (if Off, "TOCO"). Fetal Movements are displayed as Fetal Movement graphs, and automatically detected Fetal Movements, as FMDs in the form of points.

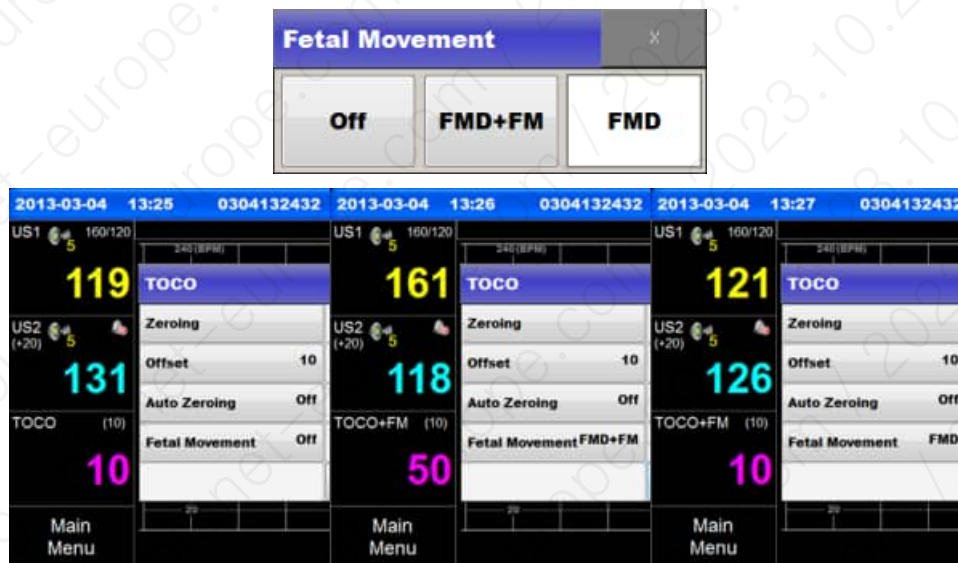

<LCD Display>

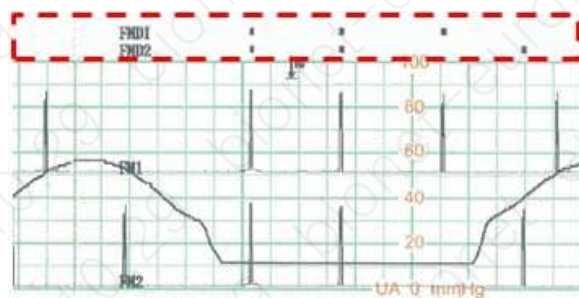

<Paper Display>

TOCO Color

This is used to set up TOCO values and Trace line colors.

Chapter 7. Fetal movement measurement

Fetal Movements can be measured in two methods: automatic detections from data entered in ultrasounds and measurement by pressing a marker jack when the patient feels fetal movements.

☐ Method using a marker jack

This is a method of recording fetal movements by relying on maternal perception for the time points of fetal movements by having the patient press the button on the marker jack. When the marker jack has been pressed, “|” will be displayed in the FHR waveform display area.

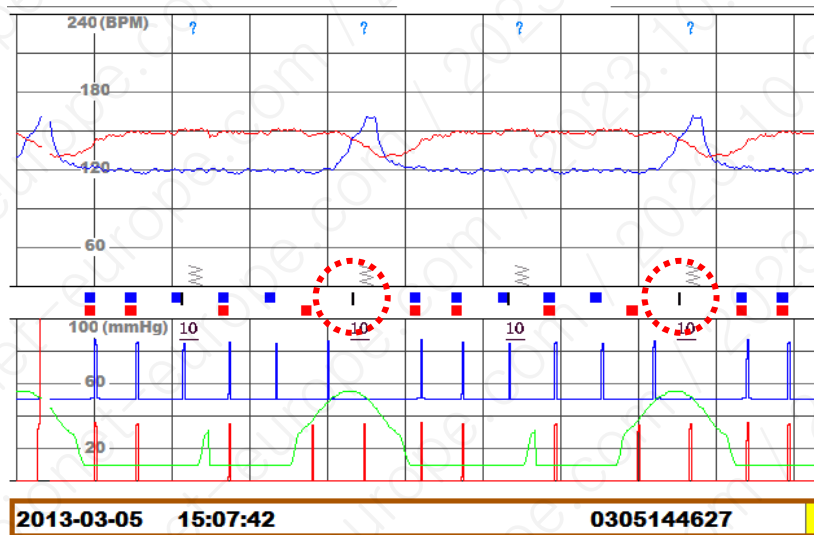

<LCD display>

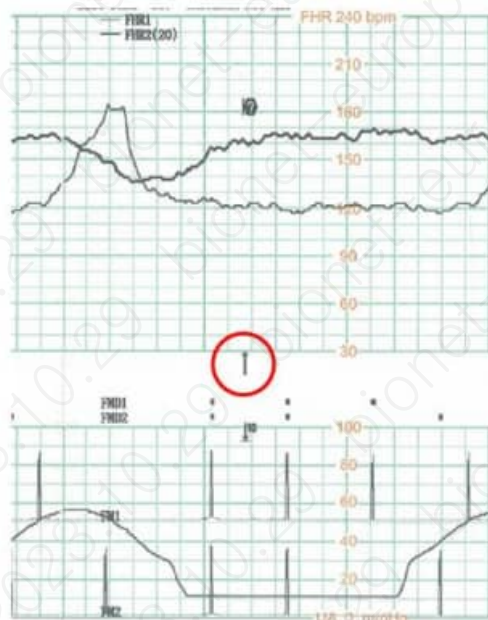

<Paper display>

▣ Marker jack



▣ Method using automatic fetal movement measurements

The automatic fetal movement measurements extract information in proportion to the sizes and durations of fetal movement from the received ultrasonic Doppler signals and display the information along with information on uterine contraction. In addition, if any of the obtained values is larger than the preset critical value of the size of fetal movements, the values will be marked as points in the UA waveform display area. Please refer to Chapter 9 (TOCO measurement) on how to set up the critical value

▣ Setting the sound of Marker jack measurement

To turn ON/OFF the sound of pressing Marker jack, touch the Main Menu->System-> Marker Sound.

Chapter 8. Stimulator

When stimulator has been pressed, simulator symbol will be displayed on the screen.

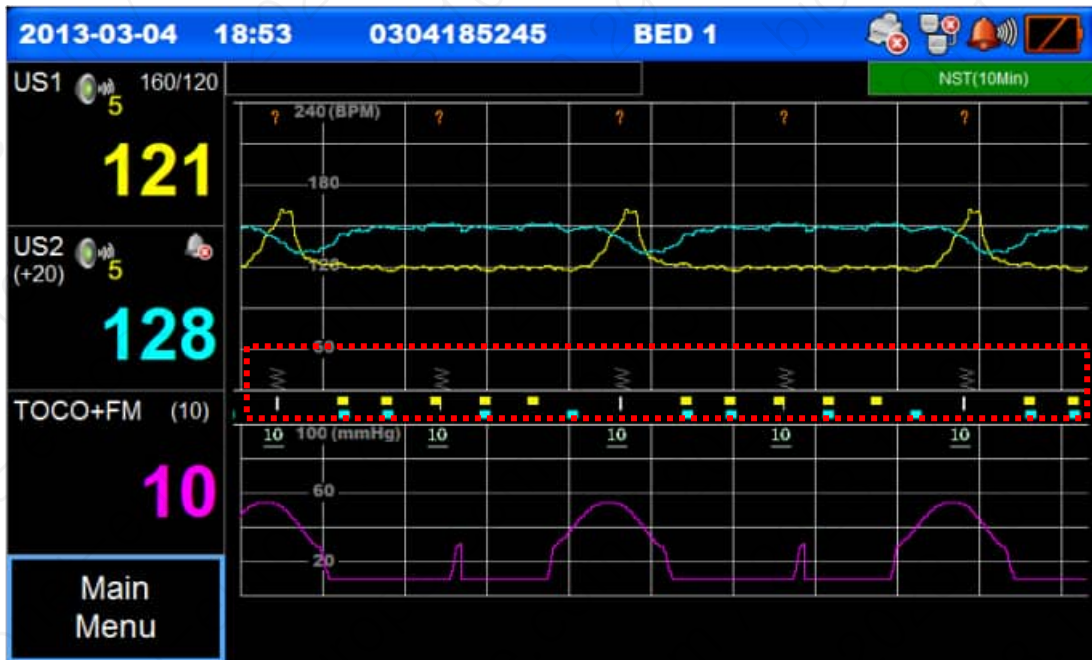

<LCD display>

Warning



A stimulator can be used such as the GE stimulator or GE compatible products.
Please use a safety secured stimulator.

Chapter 9. Clinical Mark and Note

To record clinical mark in real time, use Clinical Mark button. When Clinical Mark key is shortly pressed, Clinical mark will be entered, and Clinical Mark will be displayed when Trace range and Real time is printed. Clinical mark will be displayed in Orange triangle and same in Print. When Clinical Mark key is long pressed,, Note window will pop up, and when one of the lists is selected, related information will be displayed in Trace and Real time.



: Clinical Mark Key

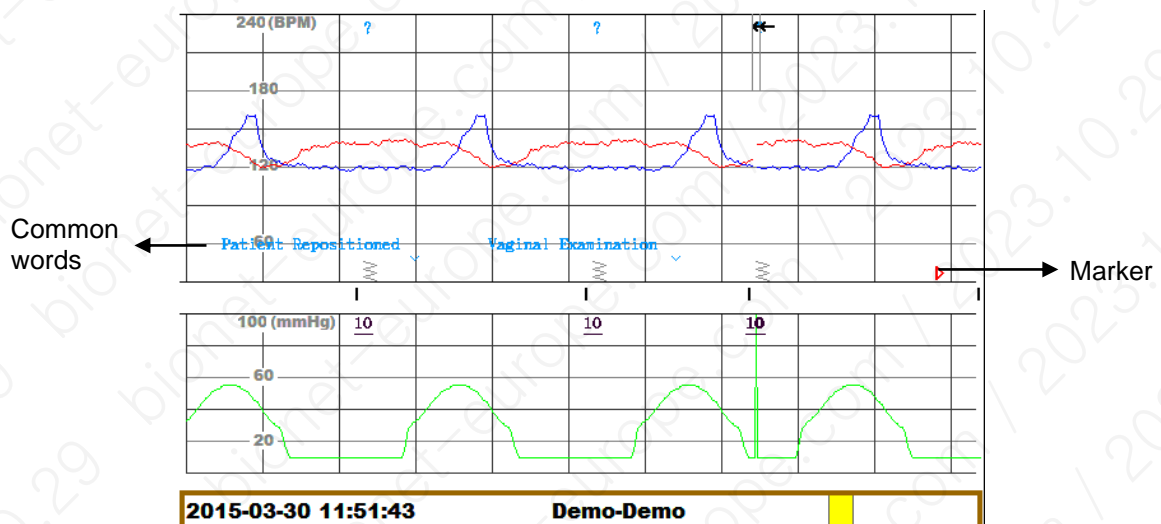

FC1400 Operation Manual

■ Entering Note

When Clinical Mark key is long pressed, note screen will be printed. Press OK after selecting related item from the list, and Trace and Real time Note will be printed.

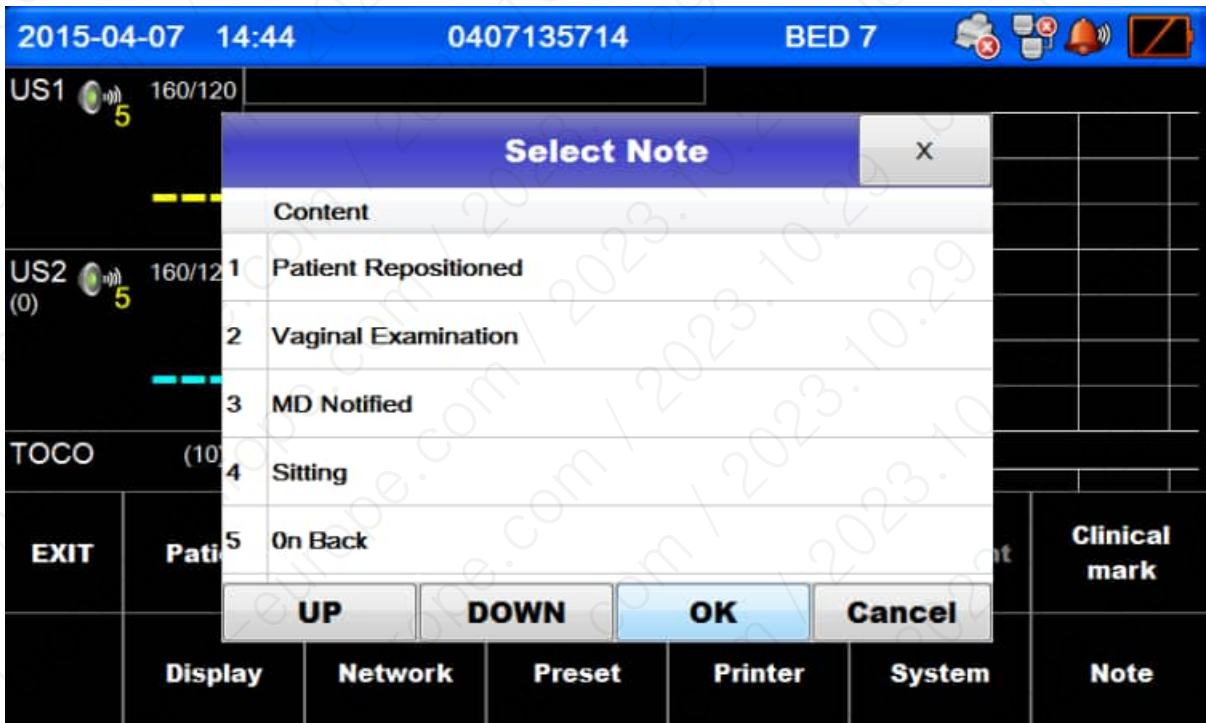

■ Adding Note

Note lists can be added and edited by Users having Administrator rights. Touch Main menu->system->Edit Note and enter the Admin password, and then set the user environment using New/Edit/Delete button.

However, the additional number of notes that can be saved is only 100.

NOTE

Preset 15 lists cannot be edited nor deleted.

To preset password, refer to Chapter 11, alarm and preset setting.

Chapter 10. Trace

The saved measurement results may be viewed using the Trace function. Data measured for 72 hours are saved. Trace data can be reprinted or copied as images to USB

1) Trace area

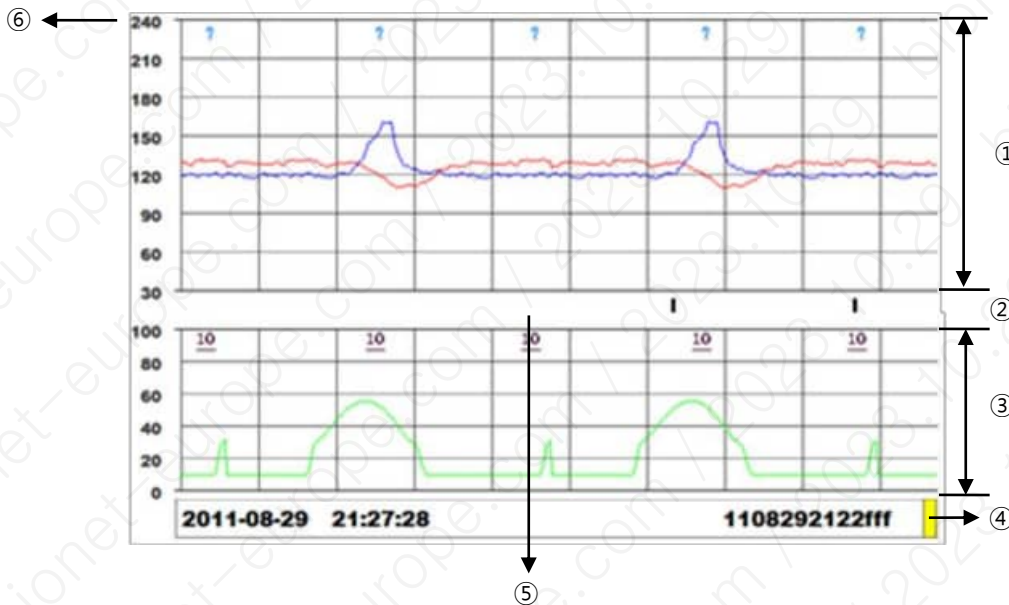

- ① These are data for an area of 30~240bpm, which indicate the traces of fetal heart rates. Markers or note entries are displayed at the bottom grids.
- ② FMD: Automatically detected fetal movements are displayed.
- ③ TOCO values in the range of 0~99 Units; ditto for graphs of fetal movements detected from US.
- ④ Scroll bar: This is used to move the time point of Traces. Time points may be moved by touching the scroll bar or by using the cursor movement key on the operation panel.
- ⑤ TOCO Zeroing: This indicates that TOCO Zeroing has been done.
The figure above shows Zeroing.
- ⑥ Grid: This indicates the standard of the grids.

2) Trace

Trace

To view trace data, touch Trace in the main menu.



: Trace Key

Changing trace time

Trace data times may be changed by moving the scroll bar on Trace, by using volume adjustment keys on the operation panel or by touching the left or right of trace window.

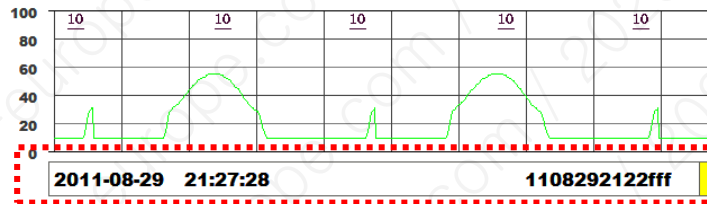

If US1 volume up key is pressed, the view will be moved to earlier 1 min; if US2 volume up key is pressed, the view will be moved to later 1 min.

If US1 volume down key is pressed, the view will be moved to earlier 6 secs; if US2 volume down key is pressed, the view will be moved to later 6 secs.

If the left side of LCD is touched, the view will be moved to earlier 10 min; if the right side of LCD is touched, The view will be moved to later 10 mins.

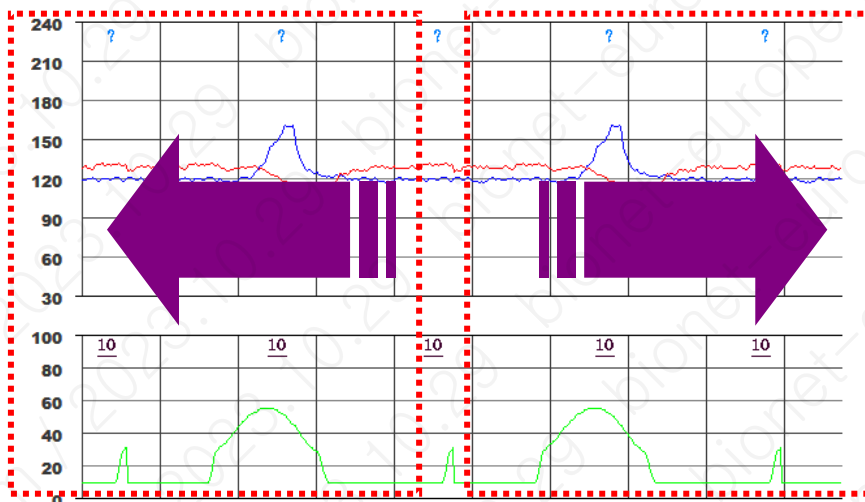

▣ Exiting the Trace screen

To view data entered in real time when the Trace screen is displayed, touch the Main Home of the Trace menu or the “screen switching or function key” on the operation panel.



: Home and function key

3) Setting up trace modes

Touch the menu in the Trace screen. The Trace menu will then appear.

EXIT				Data Save	Print Start	Main Home

▣ Print

Print 'Trace' data of a fixed duration. In this function, the device will print up to 1 hour of data starting from the point of 'Trace' on the current screen. If the patient is discharged before the 1 hour mark, then only the data up to discharge will be printed.

FC1400 Operation Manual

▣ Data Save

Trace a period of time, stored on a USB storage device. When you insert a USB storage device is displayed on the LCD screen on the right. Trace mode from the main menu, touch the “Data Save” button appears.



When "Data Save" is touched, data will be saved to USB. The first position of the Trace of current screen will be saved as data image up to 3hrs within one page. Duration will depend on the print speed, 30 min for 3cm/min, 60 min for 2cm/min and 90 min for 1cm/min. In the situation of patient change, the data until before the change will be saved.

The following windows appear, approximately 10 seconds after the end of the progress bar window disappears automatically. Data storage device recognition can be found at the path "\NewFC1400\data".

The name of the file will be saved "{Patient ID}_{Patient Name}_{(Gestational-age)}_{Year Month Day Hour Minute Second}.jpg".



Warning	
	Do not remove USB from the device during the data transportation.

▣ Main Home

The system will exit the Trace mode, and data will be output in real time.

Warning	
	Trace data is saved periodically by every 1 minute. Thus, up to 1 minute from the end of data may not be saved. Additionally, no data will be saved if the device is turned off within 1 minute of powering on.

Warning	
	Trace data may be erased after the SW upgrade.

Chapter 11. Print

FC1400 has two Trace print function, real time and previous data print. In the printing process, print icon can be seen on the right top. Two types of Print icons, 'printing' and 'print stop', exist.



(Printing)



(Not Printing)

To start or stop print, press the following Print key. For the normal start or stop print, press the button for short. To accelerate the paper, press the key continuously and feed the paper. When hand is removed from the key while feeding, max. 2.5cm will be additionally printed and feeding will stop.



: Print start/Print stop key

1) Printing in real time

To print currently inputted data, touch the print icon on the operation panel or "Print Start" in the menu.

If any printing is in progress, a print icon will be displayed on the upper right side of the screen.

To stop printing, touch the print icon on the operation panel again or touch "Print Stop" in the menu.

When printing in real time has been stopped, paper will be fed in a certain length to be cut.

Printing in real time may be done in any of three speeds: 1, 2, 3 cm/min.

▣ Changing the speed of printing in real time

To change the speed of printing in real time by the equipment, touch the main menu → Printer. Touch the item "Speed" in the menu and select the desired speed to change the speed.

Printing speeds will not be changed during a printing. To change the speed, stop the printing, change the speed, and then print again.

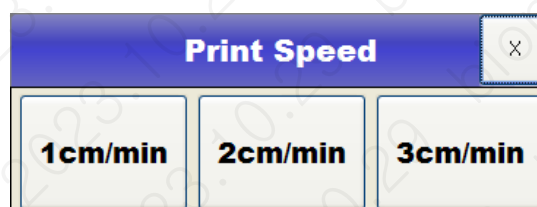

▣ Changing the type of printing paper

To change the type of paper, touch the main menu → Printer. Touch the item “Scale” in the menu and select the desired type of paper to change the type



▣ Changing the intensity of line

To change the intensity of paper, touch the main menu → Printer. Touch the item “intensity” in the menu.

▣ Changing the size of printing paper

To change the size of printing paper, touch the main menu → Printer. Touch the item “Size” in the menu and select the desired size of printing paper to change the size.

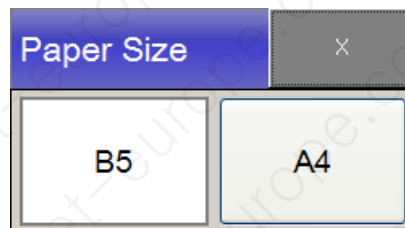

▣ Changing the grid line printing

To print grid line on the paper, touch the main menu → Printer. Touch the item “grid” in the menu. If the grid is on, the grid line is printed on the paper.

2) Trend printing

To print trend data, please move to the point from which you want to print on the Trend window and press Print. The trend will then be printed up to the next measurement or for the time designated in advance.

3) Paper replacement

If the paper is off during printing, "No paper" alarm occurs.

If "No paper" alarm occurs, load paper or push "alarm silence" button to clear "no paper" alarm status

You can open printer cover by pushing "Printer cover open" lever to the right. Load paper with printable side up and close the cover.

4) Hospital name

To set hospital name on printing paper, touch main menu → Printer. Touch the "Hospital" in the menu.

Hospital name can be up to 100 letters.

Chapter 12. Alarm and preset

Alarms are largely divided into patient condition alarms and product condition alarms.

1) Patient condition alarm

Patient condition alarms will sound when the value exceeds the maximum and minimum limit values for alarms; there are two levels of alarms: Medium and Low. These differ in terms of the order of ringing and volume.

Medium alarms will be shown as ** on the alarm list when they occur, and Low alarms, as *.

Certain alarms will occur after their set alarm delay time.

If more than one alarm sounds, alarm messages will appear successively on the alarm condition window. An arrow next to an alarm message means that there is more than one message.

If two or more alarms occur, the alarm at the highest level will sound.

MEDIUM	A low-pitched sound will be repeated three times and paused for a while.
LOW	A low-pitched sound will be repeated two times and paused for a while.

2) Product condition alarm

Product condition alarms inform the user that the monitor cannot operate properly and indicate that the detections of dangerous conditions of the patient cannot be trusted.

There are several alarms sounds for product condition alarms.

“Ding-dong”	When the connector is being disconnected
Technical Alarm	A low-pitched sound will be repeated one times and paused for a while.

3) Visual Alarm

Alarm messages appear in the Alarm Status Area on the screen. If more than one alarm occurred, messages are changed every two seconds, with an arrow displayed next to the messages. The colors of the alarm messages match the levels of the alarms. Medium Alarms are displayed in red, Low Alarms, in yellow, and product condition alarms, in sky blue. The asterisks next to alarm messages also match the levels of alarms. ** indicates medium alarms, * indicates Low Alarms, and no asterisk indicates equipment condition alarms.

When a patient condition alarm occurs, the color of the numerical value in the numeral window will be changed to red.

Visual Alarms will be maintained even after identifying the alarm statuses.

4) Alarm LED

There are two types of Alarm LED around the exterior to help checking the alarm condition from far.

Yellow LED: Alarm occurred due to patient condition.

Medium Alarm: Flickering once a second.

Low Alarm: Stay on

Green LED: Alarm occurred due to Technical Alarm and stays on.

5) Audible Silence and Pause

When various alarms occur during the operation, this function is used to silence or pause them, while the user is verifying the message. If "Alarm silence" button is clicked one time, the device will go silence for 1 minute. If a new alarm occurs during the period, alarm sound will ring again. If "Alarm silence" button is clicked twice, the device will go into "Pause" state for 5 minutes. Under "Pause" no alarm will sound even if a new alarm is generated. If "Alarm Silence" button is clicked three times, any sound alarm will be turned off and no sound will be made even if a new alarm occurs.

Visual alarm will be displayed until the situation is resolved.

To silence the alarm, touch "Alarm silence" button on control panel.



: Alarm Silence Button

Warning



When monitoring patient conditions, do not rely solely on audible signals. Reducing or turning off the volume of audible signals may endanger the patient.

6) Alarm Latching

Audible alarm will continue to ring until the situation is resolved. If no responsive action is taken, it will continue to ring until the user takes an appropriate action. Once the user takes action and alarm situation is over, both audible and visual alarm will disappear.

7) Alarm history

This is a function of making the history of Alarms that occurred visible. When the alarm message area on the screen has been touched, an alarm history window will appear.

If the patient is admitted, the alarm history is cleared.

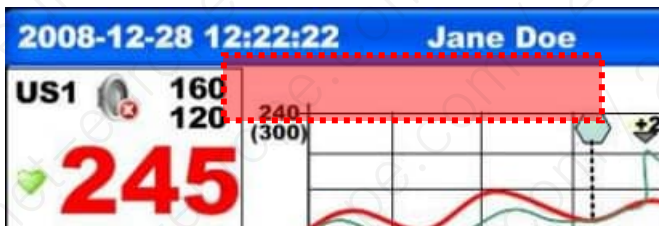

Alarm History		X
2011-09-23 11:52:04	FHR1 130 > 128	
2011-09-23 11:51:33	FHR2 160 > 128	
2011-09-23 11:50:50	FHR2 160 > 131	
2011-09-23 11:50:22	FHR2 160 > 128	
2011-09-23 11:48:54	FHR1 149 > 119	

UP DOWN

8) Preset

It is a function which standard settings can be only changed by authorized person. Volume adjusting function applies to current patient, and when device is restarted or moved to another patient, it turns on to preset function value. But, if the device is turned off abnormally and turned on within 30sec, it recognizes as same patient and maintains previous setting value.

Preset function consists of alarm volume, alarm function usage, alarm range, alarm level, alarm delay time, US1 Volume, US2 Volume.

To proceed alarm preset function, touch Main Menu->Preset.

As an authorized person only can set the function, enter the password in order to move to setting menu.

WARNING



The initial Preset Password in Factory mode is "1234". Change Preset Password after installation to avoid use by unauthorized person. To change the Preset Password, touch Main Menu->System->Change PW and enter password. Please be aware, when the changed password is lost by users, the only way to use the device is initializing to factory mode. When initialized, all data will be removed. Please keep the password in safe place.

9) Alarm volume adjustment

Audible Alarms can be adjusted to 1~5 levels of volume or may be muted.

① Touch "Main Menu->Preset->Alarm Volume"

② Selected the desired volume on the popup window.

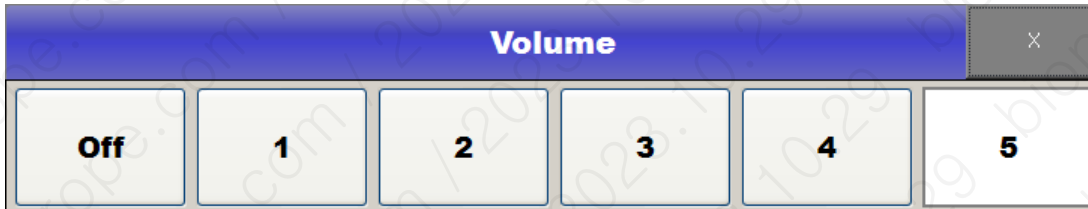

③ Check if the current alarm volume is displayed on the alarm icon on the screen.



: Alarm Volume condition icon; to be set to levels 1~5



: Alarm Volume off icon; alarms occurring will not be heard



: Alarm silence



: Alarm pauses

10) Setting all alarms ON/OFF

This function is either to activate or deactivate alarm for each parameter. Touch Main Menu->Preset->Alarm On/Off and set the condition by pressing in Alarm Parameter window.

Default Value: FHR1 : On

FHR2 : On

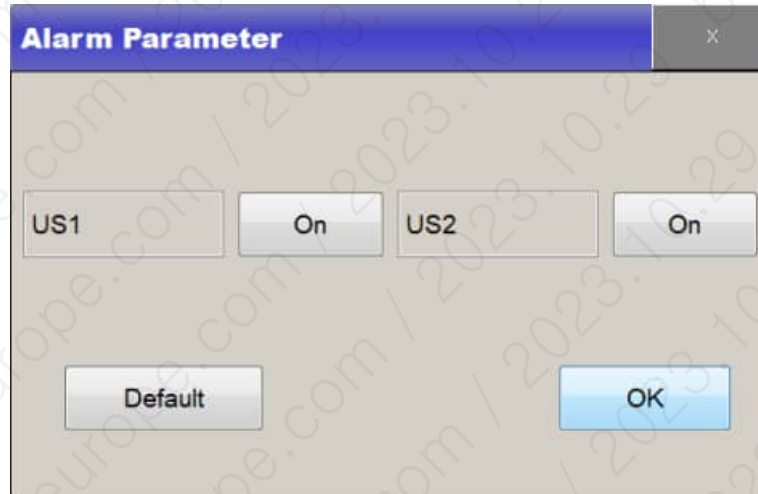

11) Setting all alarms ranges

This function allows users to select alarm ranges for each parameter. Touch "Main Menu->Preset->Alarm Limit" and click button on "Alarm Limit" window to change, in order to set the default values, touch "Default" then select "OK" button.

Default Value: FHR1 : 160~100 bpm

FHR2 : 160~100 bpm

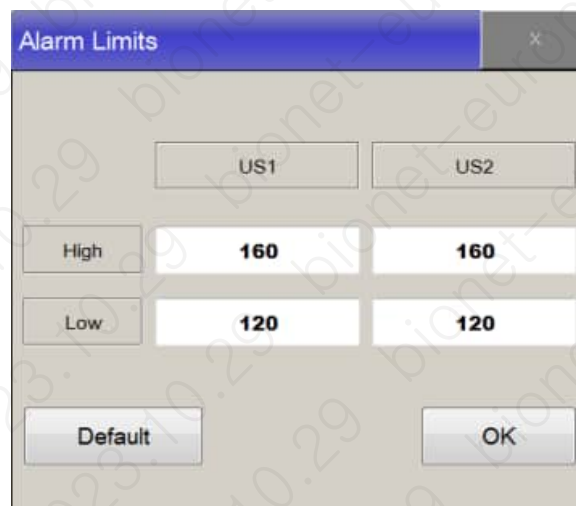

12) Setting all alarm levels

This function allows users to select alarm levels for each parameter. Touch "Main Menu->Preset->Alarm Level" and click button on "Alarm Level" window to change, in order to set the default values, touch "Default" then select "OK" button.

Default Value : FHR1 : Medium

FHR2 : Medium



13) Default Setting

This function is used when setting values in "Alarm Parameter", "Alarm Limit" and "Alarm Level" sections to their default values. Click on the menu button to apply setting.

To set the Default value, touch "Main Menu->Preset->Default Setting". Refer Chapter 19 for default value.

NOTE

When using the device through FC central, all setting values will be synchronized once the device is out of main menu and parameter window.

14) Signal Loss Alarm

Signal Loss Alarm occurs when lost FHR for a certain period and unable to detect FHR.

100 % Signal loss: Absent FHR for last 75 seconds.

70 % Signal loss: Less than 30% acceptable FHR for last 5 minute.

65 % Signal loss: Less than 35% acceptable FHR for last 10 minute.

The signal loss alarm is enabled/disabled on the US1 and US2 menu.

Chapter 13. Network

To set up network configuration, touch the Network in the menu.

EXIT	IP	Central Server	Wireless :Off	Central :Off	Bed Num :7	
Up						

- IP : NewFC1400 Network information

- Central IP : Central server information

- Wireless setting

If you use the Wireless LAN, wireless LAN module is inserted into the USB slot on the rear side, and the touch the Wireless menu, and the touch the central menu

When "On" the wireless LAN function is activated. IP button then touch the screen that appears depends. When "Off" wired LAN function works.

Using wireless LAN FCCentral for more information, please refer to the separate document on how to connect.

FC1400 Operation Manual

■ Central setting

If you set the state "ON" by touching "Central" button, the device can be connected to the Central. If you set the state "Off", the connection will be terminated.

Warning



First, check the Wireless LAN module equipment to make sure that it is properly seated, before Central of state and Wireless change "On"

Wireless is not set to "On" in unrecognized status.

Warning



VLAN network

If data is exchanged within a single network, an independent VLAN network for the clinical information system must be established.

A network system that detects and defends against denial-of-service attacks must be established through the installation of equipment dedicated to DDos defense.

When using wireless, ensure proper AP security, and if not, a wired connection is recommended.

Mandatory Action



DO NOT REMOVE the USB device until it recognized completely.

■ Changing the bed number

To change the Bed number, which is designed to identify the equipment, touch "Bed Num" in the setting menu.

The Bed number can be selected from 1~16

NOTE

Wireless AP's ID are recognized only if using alphanumeric characters.

Chapter 14. General setting

Go to “System” in the main menu to define the general settings.

Main Menu =>	EXIT	Patient	Trace	Alarm History	Print Start	Wave Print	Clinical mark
		Display	Network	Preset	Printer	System	Note

The following is the setting menu:

EXIT	Date	Time	Lang :English	Version	Touch Tone :3	Demo :Off
Up	Edit Note	Marker Sound:On	Factory	Change Admin PW	Volume range: 3	Protocol Version:1.0

1) Date changing

To set up a date, touch the Date in the setting menu.

2) Time changing

To set up a time, touch the Time in the setting menu

3) Language changing

To set up a language, touch the “Lang” in the setting menu

4) Version information

To verify the version information, touch the “version” in the setting menu

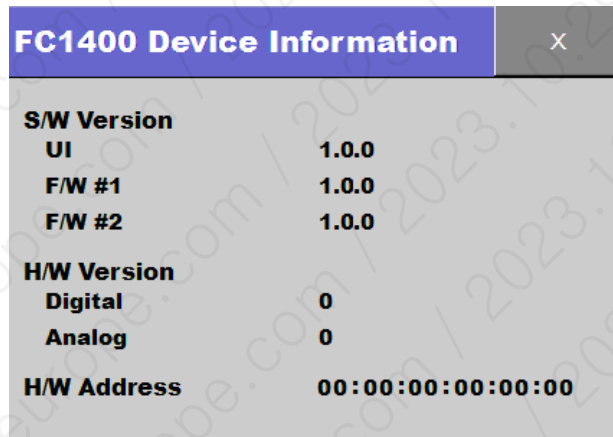

FC1400 Device Information		X
S/W Version		
UI	1.0.0	
F/W #1	1.0.0	
F/W #2	1.0.0	
H/W Version		
Digital	0	
Analog	0	
H/W Address	00:00:00:00:00:00	

S/W Version

UI : UI Software version

F/W #1 : Fetal module firmware version

F/W #2 : Printer module firmware version

H/W Version

Digital : Digital board version

Analog : Analog board version

5) Changing the Touch volume

To change the volume of touch sound, please touch the “Touch Tone” in the setting menu.

The volume can be selected from Off and 1~5.

6) Demo operation

To operate the equipment as a demo, touch the Demo in the setting menu to set the demo mode to On.

7) Edit Note

Touch for New/Edit/Delete of Note list. This function can be only used by administrator. When correct Preset password is inserted, setting window will popup. Refer to Chapter 9, Clinical Mark and Note, for more information.

8) Marker sound

Touch to turn ON/OFF the sound when clicking Marker. Refer to Chapter 7, Fetal movement measurement, for more information.

9) Factory

Only the administrator can enter Factory mode. In order to change the content, request for A/S through Headquarter or agency.

10) Change Admin PW

Click this menu to change Admin password. For the initial touch, current Admin password has to be entered and if it is confirmed, it can be changed by entering new and confirming password.

Default Admin password is "1234".

Warning	
	Admin password cannot be recovered after change. If password is lost, reset to Factory mode is the only way, and all the measured data and set values will be lost. Please keep the password safe.

11) Volume range

Click this menu to change volume range. If you want the loudest than volume range 7 or the quietest than volume range 0.

12) Changing the screen output mode

The screen supports two output modes: Graphic Mode and Text mode. To change a screen output mode, please touch the "screen switching and function key" on the operation panel in the main menu.



: Home and function key

13) Protocol Version

Set the version of protocol according to the version of FC Central. To use "Note" function in FC Central, set the protocol version 1.2 and FC Central version 1.2.2 or higher.

Chapter 15. NST

The Non-Stress Test Timer measures the NST time that passed. This function helps users measure for the designated time only.

1) NST measurement

▣ Starting NST

Touch "print key". When the set NST time has passed, alarms will sound to inform the user that the NST measurement has been finished.

To silence "NST ending" alarm, Touch "Alarm silence" button on control panel.

▣ Stopping NST

If Print key is touched, the current NST will stop. At this time, the printing will also stop.

2) NST Setting

Clicking "Main menu->Setting->Printer->NST" causes the following setting window to pop up.



▣ NST Time

This is used to set the NST Time.

The time period can be selected from OFF, 10, 20, 30, 40, 50, 60, and 90 mins.

Chapter 16. CTG terms

CTG is interpreter function by FHR and TOCO.

If you choose on, base FHR values will be printed out 10 minutes after you press print button. If you pressed print button after 10 minutes, CTG interpreter results will be printed out.

1) Setting

■ CTG Setting

Main Menu → Printer → touch CTG Print and when screen change as “CTG Print: On”, you can print out CTG result.

■ CTG turn off function

Main Menu → Printer → Touch CTG Print and when screen change as “CTG Print: Off”, it is NOT printed out CTG result.

2) CTG Output

■ Start CTG

CTG analysis starts when you start real time printing. The CTG analysis result requires equal to or more than 10 minutes printing.

■ Stop CTG

When you stop real time printing, you can find print of CTG final result after 5 seconds.

If you want to print out CTG final result, you have to measure data at least 10 minutes.

3) CTG Measurement results

After measuring CTG, the result will be printed out as below.

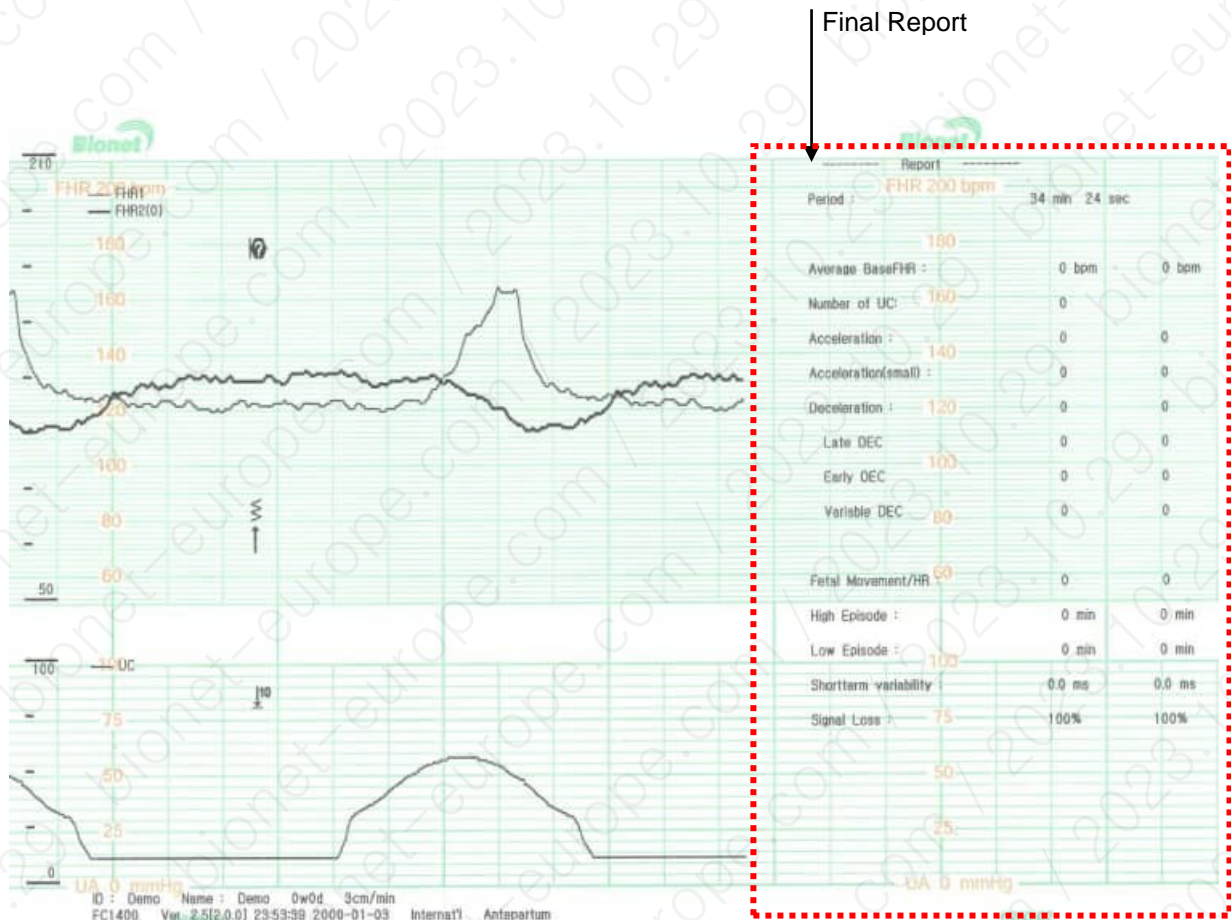

4) Glossary of CTG Terms

■ Base FHR/ Average Base FHR

Except Constant FHR, irregular FHR, extreme changed FHR, 25bpm exceed of base line difference cases, it should be progress more than 2 minutes as 10 minutes of FHR average data.

■ Number of TOCO

It is number of uterus contractions during measurement.

■ High Episode/Low Episode

In case of under 30msec of changing width in 5 minutes is Low Episode and in case of over 32msec of changing width in 5 minutes is High Episode.

■ Short Term Variability

It is parameter about how fast fetal heart rate changed.

In case of under 2.6ms of STV result, it should be checked additionally when you think about that fetal condition is unstable.

■ Smaller Acceleration

Visually apparent increase (onset to peak is $< 30\text{sec}$) of FHR above baseline. Peak is $\geq 10\text{ bpm}$ and $< 15\text{ bpm}$. Duration is $\geq 15\text{ sec}$ and $< 2\text{ min}$.

■ Fetal movement per hour

Indicates the number of movements of the fetal in per hour.

5) ACCELERATION

Visually apparent abrupt increase (onset to peak is < 30sec) of FHR above baseline. Peak is ≥ 15 bpm. Duration is ≥ 15 sec and <2 min.

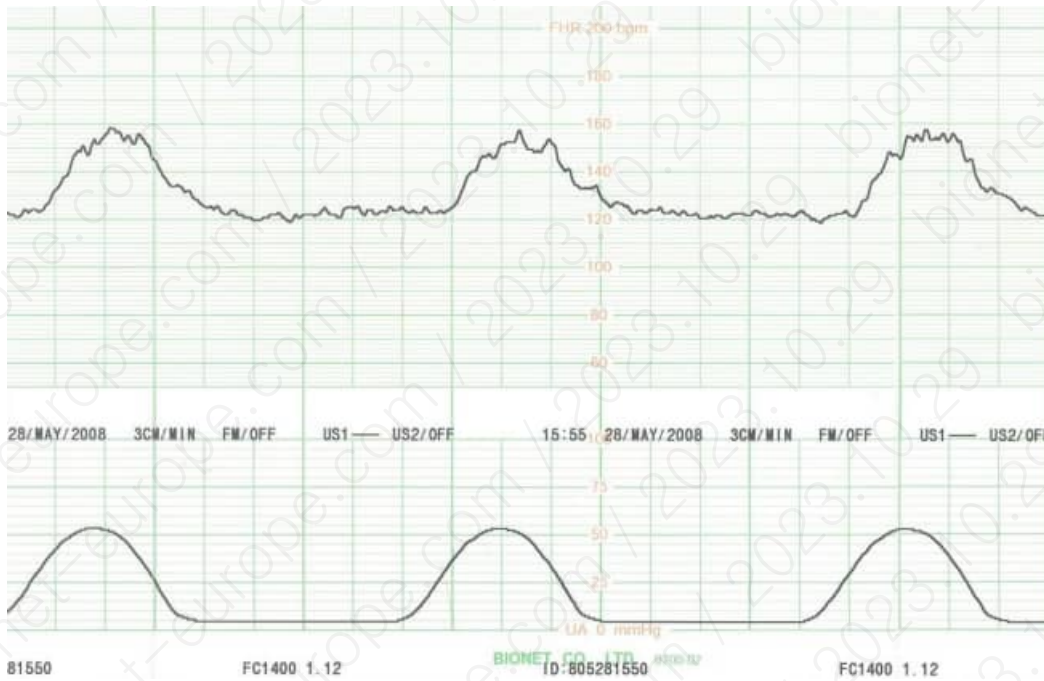

6) LATE DECELERATION

Visually apparent gradual decrease (onset to nadir is ≥ 30 sec.) of FHR below baseline. Return to baseline associated with a uterine contraction. Nadir of deceleration occurs after the peak of the contraction. Generally, the onset, nadir and recovery of the deceleration occur after same time as the onset, peak, and recovery of the contraction.

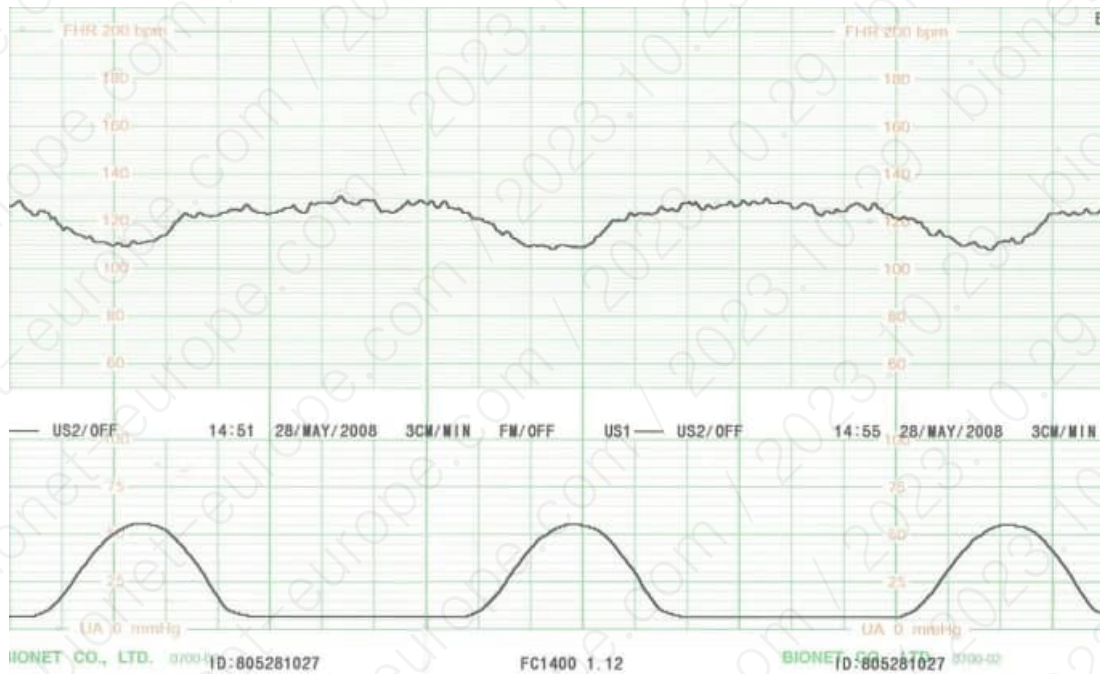

7) EARLY DECELERATION

Visually apparent gradual decrease (onset to nadir is ≥ 30 sec.) of FHR below baseline. Return to baseline associated with a uterine contraction. Nadir of deceleration occurs at the same time as the peak of the contraction. Generally, the onset, nadir, and recovery of the deceleration occur at the same time as the onset, peak and recovery of the contraction.



8) Variable DECELERATION

Visually apparent abrupt decrease (onset to nadir is <30sec) in FHR below baseline. Decrease is ≥ 15 bpm. Duration is ≥ 2 min and < 10 min.

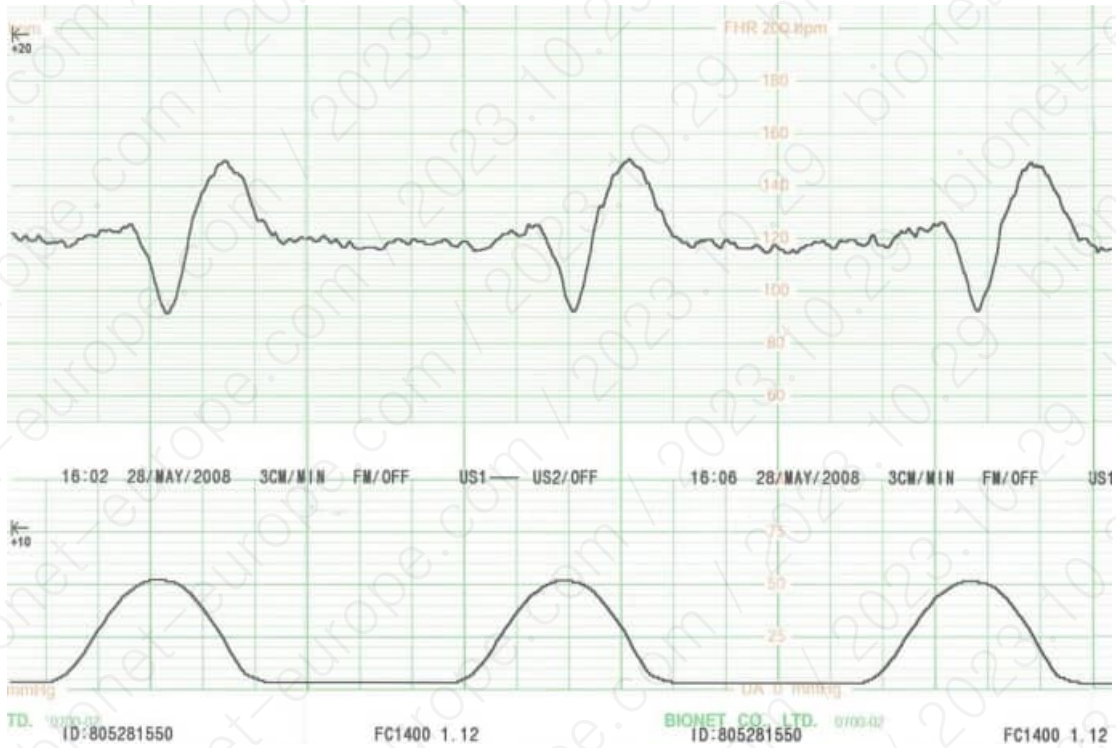

Chapter 17. Message list

1) Patient Alarm

Short Msg	Figure Msg	From
FHR* MEDIUM	FHR* xxx < yyy	FHR*
FHR* LOW	FHR* xxx>yyy	FHR*

2) INOP Alarm

Short Msg	Figure Msg
No Paper	Main
Low Battery	Main
Signal Loss	FHR* 100% Signal Loss FHR* 70% Signal Loss FHR* 65% Signal Loss

Chapter 18. Simple troubleshooting

1) Troubleshooting and solutions

- ① If the probe comes off during operation, a “---” sign will be displayed, and a “Ding” sound will be heard. In this case, check the connection condition of the probe and connect the probe again to solve the problem.
- ② If paper has run out during operation, a “Paper off” sign will be displayed on the LCD screen. In this case, please open the printer, check if the recording sheets have run out, replenish the record sheets, and close the printer to solve the problem.

Warning



If Touch Calibration is not properly set, the system may not operate properly. You must calibrate the touch input as written in the operation manual..

2) Performing periodic inspections

Just like all kinds of medical equipment, please conduct safety inspections on FC1400 periodically (once a year). Refer to the service manual provided by the company for the inspection items.

3) Cyber security issues

1. If equipment is stolen or lost, immediately report it to the hospital staff or manufacturer. Upon receipt of a report, the hospital network administrator must take measures to prevent the device from accessing the hospital network.
2. If a cyber security threat is detected while using the device, immediately disconnect the device from the network and contact the hospital staff or manufacturer.

※ For manufacturer contact information, please refer to the table of contents of how to contact us.

Chapter 19. Product specification

General specification

Dimension	296(w)x.305.5(H)x97.5(D)(Approx. 2.9Kg)	
Display	7" Wide Display 800 X 480 pixel resolution	
Environment	Operating temperature: 10 ~ 40°C Operating humidity: 30 ~ 85%RH Operating Atmospheric pressure: 70 ~ 106KPa Storage / Ship temperature: -20 ~ 60°C Storage / Ship humidity: 10 ~ 95%RH Storage / Ship Atmospheric pressure: 50 ~ 106KPa	
Printer Resolution	Thermal print head, Roll paper 1,2,3cm/min,(Real time) 30cm/min (Trace, 2,3 cm/min setting) 20cm/min (Trace, 1 cm/min setting)	
Patient accessible part	US1, US2, TOCO, Marker, Stimulator	
	UC	0 ~ 99 unit

Performance Specification

Fetal Heart Rate	Input Signal : Ultrasound pulsed doppler FHR detection method : Autocorrelation FHR range : 50~210 FHR accuracy : 120~160 : ±1 bpm Except 120~160 : ±2 bpm
Ultrasound Transducer	Operating mode : PWD Mode Transducer Type : 7-crystal Ultrasound frequency : 1.0MHz Pulse Repetition Frequency : 3150Hz Spatial-Peak Temporal Average Intensity : <10mW/cm2
Uterine Contraction	Input Source : External Transducer Reference Control : One touch switch Auto zeroing Measurement range : 0~99
Auto CTG Analysis	Average Baseline FHR Number of TOCO Number of Acceleration Number of Deceleration : Late, Early, Variable High/Low Episode Short term Variability Signal Loss * CTG Analysis results is printed out every 10 minutes

Default Alarm Setting

Alarm Parameter	US1/ US2	ON
Alarm Limit	US1/US2	160 120
Alarm Level	US1/US2	Medium

■ Intended Use

FC1400 is a fetal monitoring device used to measure Fetal Heart Rates (FHR), degree of maternal uterine contraction (UA: Uterine Activity), fetal movements (FM). FC1400 shoots ultrasounds to the abdomen of the patient. From the signals returned after being reflected by the heart of the fetal, FC1400 extracts Doppler frequencies that vary with the movements of the heart of the fetal to output changes in the heartbeats of the fetal as sounds for the analysis of the signals; thus detecting the heart rates and fetal movements of the fetal. In addition, it detects the degrees of uterine contraction of the patient using a pressure sensor. It indicates the fetal heart rates, maternal uterine activity, fetal movements, on its LCD screen as figures and saves the information to its memory.

■ Claimed indications

- Previous history of stillbirth
- Complications of pregnancy
- Induction of Labor
- Preterm labor
- Nonreassuring fetal status; fetal movement

■ Contraindications : Unknown

Appendix A. Manufacturer's declaration - electromagnetic immunity

The **FC1400** system is intended for use in the electromagnetic environment specified below.
The customer or the user of the **FC1400** system should assure that it is used in such an environment

Immunity test	IEC 60601 Test level	Compliance level	Electromagnetic Environment -guidance
Electrostatic discharge (ESD) IEC 61000-4-2	6 kV Contact 8 kV Air	6 kV Contact 8 kV Air	Floors should be wood, concrete or ceramic tile. If floors are covered with synthetic material, the relative humidity should be at least 30 %
Electrical fast Transient / burst IEC 61000-4-4	2kV for power supply lines 1kV for input/output lines	2kV for power supply lines 1kV for input/output lines	Mains power quality should be that of a typical commercial or hospital environment.
Surge IEC 61000-4-5	1 kV differential mode 2 kV common mode	1 kV differential mode 2 kV common mode	Mains power quality should be that of a typical commercial or hospital environment.
Power frequency (50-60Hz) Magnetic field IEC 61000-4-8	3.0 A/m	3.0 A/m	Power frequency magnetic fields should be at levels characteristic of a typical location in a typical commercial or hospital environment.
Voltage dips, short Interruptions and Voltage variations on power supply input lines IEC 61000-4-11	<5% U_T (>95% dip in U_T) for 0.5cycle 40% U_T (60% dip in U_T) for 5 cycle 70% U_T (30% dip in U_T) for 25 cycle <5% U_T (<95% dip in U_T) for 5 s	<5% U_T (>95% dip in U_T) for 0.5cycle 40% U_T (60% dip in U_T) for 5 cycle 70% U_T (30% dip in U_T) for 25 cycle <5% U_T (<95% dip in U_T) for 5 s	Mains power quality should be that of a typical commercial or hospital environment. If the user of the system requires continued operation during power mains interruptions, it is recommended that the system be powered from an uninterruptible power supply or a battery

Note: U_T is the a.c. mains voltage prior to application of the test level.

FC1400 Operation Manual

The **FC1400** system is intended for use in the electromagnetic environment specified below. The customer or the user of the **FC1400** system should assure that it is used in such an environment

Immunity test	IEC 60601 Test level	Compliance level	Electromagnetic environment - guidance
Conducted RF IEC 61000-4-6	3 Vrms 150 kHz to 80 MHz	3 Vrms 150 kHz to 80 MHz	<p>Portable and mobile RF communications equipment should be used no closer to any part of the system, including cables, than the recommended separation distance calculated from the equation applicable to the frequency of the transmitter.</p> <p style="text-align: center;">Recommended separation distance</p> $d = \left[\frac{3,5}{V_1} \right] \sqrt{P}$
Radiated RF IEC 61000-4-3	3 V/m 80.0 MHz to 2.5 GHz	3 V/m 80.0 MHz to 2.5 GHz	<p style="text-align: center;">Recommended separation distance</p> $d = \left[\frac{3,5}{E_1} \right] \sqrt{P} \quad 80 \text{ MHz to } 800 \text{ MHz}$ $d = \left[\frac{7}{E_1} \right] \sqrt{P} \quad 800 \text{ MHz to } 2,5 \text{ GHz}$ <p>Where P is the maximum output power rating of the transmitter in watts (W) according to the transmitter manufacturer and d is the recommended separation distance in meters (m).</p> <p>Field strengths from fixed RF transmitters, as determined by an electromagnetic site survey,</p> <p>(a) Should be less than the compliance level in each frequency range (b).</p> <p>Interference may occur in the vicinity of equipment marked with the following symbol:</p> <div style="text-align: center;">  </div>

Note 1) U_r is the A.C. mains voltage prior to application of the test level.

Note 2) At 80 MHz and 800 MHz, the higher frequency range applies.

Note 3) These guidelines may not apply in all situations. Electromagnetic propagation is affected by absorption and reflection from structures, objects and people.

FC1400 Operation Manual

a Field strength from fixed transmitters, such as base stations for radio (cellular/cordless) telephones and land mobile radios, amateur radio, AM and FM radio broadcast and TV broadcast cannot be predicted theoretically with accuracy. To assess the electromagnetic environment due to fixed RF transmitters, an electromagnetic site survey should be considered. If the measured field strength in the location in which the EUT is used exceeds the applicable RF compliance level above, the EUT should be observed to verify normal operation. If abnormal performance is observed, additional measures may be necessary, such as re-orienting or relocating the EUT.

b Over the frequency range 150 kHz to 80 MHz, field strengths should be less than [V1] V / m.

Recommended Separation Distances Between Portable and Mobile RF Communications Equipment and the FC1400 system.

The **FC1400** system is intended for use in an electromagnetic environment in which radiated RF disturbances are controlled. The user of the **FC1400** system can help prevent electromagnetic interference by maintaining a minimum distance between portable and mobile RF communications equipment (transmitters) and the **FC1400** system as recommended below, according to the maximum output power of the communications equipment.

Rated maximum output power (W) of transmitter	Separation distance (m) according to frequency of transmitter		
	150 kHz to 80 MHz	80 MHz to 800 MHz	800 MHz to 2.5 GHz
0.01	0.12	0.12	0.23
0.1	0.37	0.37	0.74
1	1.17	1.17	2.33
10	3.70	3.70	7.37
100	11.70	11.70	23.30

For transmitters rated at a maximum output power not listed above, the recommended separation distance (d) in meters (m) can be estimated using the equation applicable to the frequency of the transmitter, where P is the maximum output power rating of the transmitter in watts (W) according to the transmitter manufacturer.

Note 1: At 80 MHz and 800 MHz, the separation distance for the higher frequency range applies

Note 2: These guidelines may not apply in all situations. Electromagnetic propagation is affected by absorption and reflection from structures, objects, and people.

Immunity and Compliance Level			
Immunity test	IEC 60601 Test Level	Actual Immunity Level	Compliance Level
Conducted RF IEC 61000-4-6	3 Vrms, 150 kHz to 80 MHz	3 Vrms, 150 kHz to 80 MHz	3 Vrms, 150 kHz to 80 MHz
Radiated RF IEC 61000-4-3	3 V/m, 80 MHz to 2.5 GHz	3 V/m, 80 MHz to 2.5 GHz	3 V/m, 80 MHz to 2.5 GHz

FC1400 Operation Manual

Guidance and manufacturer's declaration - electromagnetic immunity

The FC1400 system is intended for use in the electromagnetic environment specified below.			
The customer or the user of the FC1400 system should assure that it is used in such an environment			
Immunity test	IEC 60601 Test level	Compliance level	Electromagnetic environment -guidance
Conducted RF IEC 61000-4-6	3 Vrms 150 kHz to 80 MHz	3 Vrms 150 kHz to 80 MHz	FC1400 system must be used only in a shielded location with a minimum RF shielding effectiveness and, for each cable that enters the shielded location with a minimum RF shielding effectiveness and, for each cable that enters the shielded location
Radiated RF IEC 61000-4-3	3 V/m 80.0 MHz to 2.5 GHz	3 V/m 80.0 MHz to 2.5 GHz	Field strengths outside the shielded location from fixed RF transmitters, as determined by an electromagnetic site survey, should be less than 3V/m.a Interference may occur in the vicinity of equipment marked with the following symbol: 
<p>Note 1) These guidelines may not apply in all situations. Electromagnetic propagation is affected by absorption and reflection from structures, objects, and people.</p> <p>Note 2) It is essential that the actual shielding effectiveness and filter attenuation of the shielded location be verified to assure that they meet the minimum specification.</p> <p>a- Field strengths from fixed transmitters, such as base stations for radio (cellular/cordless) telephones and land mobile radios, amateur radio, AM and FM radio broadcast and TV broadcast cannot be predicted theoretically with accuracy. To assess the electromagnetic environment due to fixed RF transmitters, an electromagnetic site survey should be considered. If the measured field strength outside the shielded location in which the EUT is used exceeds 3V/m, the EUT should be observed to verify normal operation.</p> <p>If abnormal performance is observed, additional measures may be necessary, such as relocating the EUT or using a shielded location with a higher RF shielding effectiveness and filter attenuation.</p>			

※Description

1) Model name

(1) Model name: FC1400

2) Manufacturer's company name and address

(1) Company name: Bionet Co., Ltd.

(2) Address: 5F, Shinsegae I&C Digital Center 61 Digital-ro 31 gil, Guro-gu, SEOUL 08375,
REPUBLIC OF KOREA

3) Manufacturing business permission number and manufacturing item permission number

(1) Manufacturing business permission no.:

4) Manufacturing item permission number:

Purpose of use of the manufacturing item: Device for combining maternal uterine contraction and fetal heartbeats to show the conditions during parturitions

5) Manufacturing number, manufacturing date, and weight

(1) Manufacturing number: To be written at the back of the main body when selling the product after obtaining item permission

(2) Manufacturing date: To be written at the back of the main body when selling the product after obtaining item permission

(3) Main body dimension: 296(w) x 305.5(H) x 97.5(D)

(4) Weight: 2.6 Kg

6) Other descriptions

(1) Electric/Mechanical indications

(A)Rated voltage: 100~ 240 VAC

(B)Frequency: 50-60Hz

(C)Power consumption: Max. of 50.4W

(2) Phrase indicating that the equipment is medical equipment: To be written in the attached document

(3) Waterproof Level: Probe(IPX-1), Main equipment(IPX-0)

7) Position for attaching indications

At the back of the product after manufacturing

Appendix B. Maintenance, Care, and Service

1) Mechanical hazard

Warning	
	<p>Ultrasound probes are highly sensitive medical instruments that can easily be damaged by improper handling. Use care when handling and protect from damage when not in use.</p> <p>DO NOT use a damaged or defective probe.</p> <p>DO NOT drop the probes or subject them to other types of mechanical shock or impact.</p>

Warning	
	<p>A defective probe or excessive force can cause patient injury or probe damage:</p> <ul style="list-style-type: none">• Observe depth markings and do not apply excessive force when inserting or manipulating intercavitary probes.• Inspect probes for sharp edges or rough surfaces that could injure sensitive tissue.• DO NOT apply excessive force to the probe connector when inserting into the probe port. The pin of a probe connector may bend.

2) Biological hazard

Warning	
	<p>To avoid the risk of disease transmission:</p> <ul style="list-style-type: none">• Must use protective barriers (gloves and probe sheaths) . Follow sterile procedures when appropriate.• Thoroughly clean probes and reusable accessories after each patient examination and disinfect or sterilize as needed.• Follow all infection control policies established by your office, department or institution as they apply to personnel and equipment.

FC1400 Operation Manual

3) Electrical hazard

Warning	
	<p>In case Gel contacts internal electronic device, Defective probe may cause electrical shock.</p> <p>Prior to each use, visually inspect the probe lens and case area for cracks, cuts, tears, and other signs of physical damage.</p> <p>DO NOT use a probe which appears to be damaged until you verify functional and safe performance.</p> <p>Perform a more thorough inspection, including the cable, and connector, each time you clean the probe.</p> <p>DO NOT kink, tightly coil, or apply excessive force on the probe cable. Insulation failure may result.</p> <p>warning: To avoid risk of electric shock, this equipment must only be connected to a supply main with ground</p> <p>Do not modify this equipment without authorization of the manufacturer</p> <p>If this equipment is modified, appropriate inspection and testing must be conducted to ensure continued safe use of equipment</p> <p>Do not to touch signal input, signal output or other connectors, and the patient simultaneously.</p> <p>Refer servicing to qualified personnel of Bionet Co., Ltd.</p> <p>Power supply is specified as a part of ME Equipment.</p>

4) Probe acoustic output hazard

Warning	
	<p>Ultrasound can produce harmful effects in tissue and potentially result in patient injury. Always minimize exposure time. And keep ultrasound levels low when there is no medical benefit.</p>

5) Probe head waterproof

Mandatory Action	
	<p>From US probe bottom to 2~3 cm, waterproof IPX is possible. Do NOT immerse the probe bottom into any liquid beyond 2~3 cm from probe bottom. Never immerse the probe connector into any liquid.</p>

Appendix C. Ultrasound Power

Use of Diagnostic Ultrasound

The American Institute of Ultrasound in Medicine (AIUM) has published a document entitled "Medical Ultrasound Safety".

This three-part document covers Bioeffects and Biophysics, prudent Use and Implementing ALARA. Ultrasound users should read the AIUM documents to become more familiar with Ultrasound safety. A copy of this document is included as part of the documentation package (Document 2163920-100).

AIUM
 14750 Sweitzer Lane
 Suite 100
 Laurel, MD, USA 20707-5906
 telephone 1-800-638-5352.

In accordance with US FDA Guidelines, the overall maximum acoustic SPTA intensity for the product is limited to 100 mW/cm² and MI is limited to 1.0.

1) Measurement Precision and Uncertainty

	Center Frequency	Acoustic Power	Peak Rarefractional Pressure	Acoustic Intensity
Measurement Uncertainty	± 2 %	±5%	±15%	± 25%

2) Maximum Output Summary

Operating Mode	DOP Probe
Pulsed Doppler Mode	O

3) Maximum Probe Temperature (Degrees C)

Probe	Max Temperature		
	With TMM Phantom	In Air	Mode
US	33.2	21.6	PWD Mode

Lens temperature monitored for 30 min.

Measurement uncertainty: +-0.5-degree C.

Ambient temperature : 22.1 degree C

4) Table Key

IEC	FDA	Meaning IEC60601-2-37 / FDA&NEMA UD2,UD3
α	a	Acoustic Attenuation Coefficient / Derating factor (usually 0.3 dB/cm-MHz)
Aaprt	Aaprt	-12db Output Beam Area / Active aperture area
CMI	-	Normalizing Coefficient
Deq	Deq	Equivalent Aperture Diameter
d-6	d-6	Pulse Beam Width / Beam diameter at -6 dB
deq	deq	Equivalent Beam Diameter
f_{awf}	fc	Acoustic Working Frequency / Center frequency
lpa	lpa	Pulse-Average Intensity
lpa, α	lpa.3	Attenuated Pulse-Average Intensity
lpi	PII	Pulse-Intensity Integral
lpi, α	PII.3	Attenuated Pulse-Intensity Integral
lta(z)	ITA	Temporal-Average Intensity
lta, α (z)	ITA.3(Z)	Attenuated Temporal-Average Intensity at depth z
lzpta(z)	ISPTA(Z)	Spatial-Peak Temporal-Average Intensity
lzpta, α (z)	ISPTA.3(Z)	Attenuated Spatial-Peak Temporal-Average Intensity
MI	MI	Mechanical Index
P	Wo	Output Power / Time average acoustic power at the source
P α	W.3(Z)	Attenuated Output Power / Time average acoustic power derated to depth z
P1	Wo1	Bounded Output Power / Power emitted from the central 1cm of aperture
pi	PII	Pulse Pressure Squared Integral / Pulse intensity integral
pr	pr	Peak-Rarefactional Acoustic Pressure
pr α	pr.3	Attenuated Peak-Rarefactional Acoustic Pressure
prr	PRF	Pulse Repetition Rate / Pulse repetition frequency
TI	TI	Thermal Index
TIB	TIB	Bone Thermal Index
TIC	TIC	Cranial-Bone Thermal Index
TIS	TIS	Soft-Tissue Thermal Index
td	PD	Pulse Duration
X, Y	x-12,y-12	-12 dB Output Beam Dimensions
Z	Z	Distance from the Source to a Specified Point
Zb	Zsp	Depth for TIB / Depth at which the relevant index is maximum
Zbp	Zbp	Break-Point Depth
Zs	Zsp	Depth for TIS / Depth at which the relevant index is maximum

FC1400 Operation Manual

Acoustic Output Tables MC65R1S – Pulsed Doppler Mode

Index	MI			TIS				TIB	TIC
				scan	Non-scan		Non-scan		
					Aaprt ≤ 1	Aaprt > 1			
Global Maximum : Index Value				0.0164842	-	0.00168143	-	0.0130577	0.00869565
	IEC	FDA	Unit						
Associated Acoustic Parameter	pra	pr.3	(MPa)	0.0164807					
	P	Wo	(mW)		-	0.4		0.4	0.4
	min of [Pa(zs), I _{ta,α} (zs)]	min of [(W.3(Z1), ITA.3(z1))]	(mW)				-		
	Zs	z1	(cm)				-		
	zbp	zbp	(cm)				-		
	zb	zsp	(cm)	1.8				1.8	
	z at max. I _{pi,α}	zsp	(cm)						
	deq(zb)	deq(zsp)	(cm)					1.0865	
	fawf	fc	(MHz)	0.999572	-	0.999572	-	0.999572	0.999572
	Dim of Aaprt	X	(cm)		-	0.4	-	0.4	0.4
Y		(cm)		-	0.4	-	0.4	0.4	
Other Information	td	PD	(μsec)	59.9647					
	pr	PRF	(Hz)	3906					
	pr at max. I _{pi}	pr@PII _{max}	(MPa)	0.0175374					
	deq at max. I _{pi}	deq@PII _{max}	(cm)					1.0865	
	Focal Length	FLX	(cm)		-	2	-		2
		FLY	(cm)		-	2	-		2
I _{pa,α} at max. MI	IPA.3@MI _{max}	(W/cm ²)	0.00154839						
Operating Control Conditions	Frequency			(MHz)	1.0	-	1.0	-	1.0

Appendix D. Abbreviation and Symbol

Abbreviation and Symbol of manual or system operation is arranged in alphabetical order.

Abbreviations

AC	alternating current	A
		B
		C
C	Celsius	
cm, CM	centimeter	
		D
DC	direct current	
		E
EMC	electromagnetic compatibility	
EMI	electromagnetic interference	
		F
F	Fahrenheit	
		G
g	gram	
		H
HR	heart rate, hour	
Hz	hertz	
		I
Inc	incorporated	
		J
		K
kg, KG	kilogram	
		L
L	liter, left	
lbs, LBS	pounds	
LCD	liquid crystal display	
LED	light emitting diode	
		M
M mean,	minute	
m	meter	
MIN,	min minute	
MM, mm	millimeters	
MM/S	millimeters per second	
MMHG, mmHg	millimeters of mercury	
mV	millivolt	
		N
		O
		P

FC1400 Operation Manual

		Q
		R
		S
sec	second	T
Temp, TEMP	temperature	U
		V
V	volt	W
		X
X	multiplier when used with a number (2X)	Z

Symbols

&	and
°	degree(s)
>	greater than
<	less than
-	minus
#	number
%	percent
±, +/-	plus, or minus

Product Warranty

Product name	Fetal monitoring device	
Model name	FC1400	
Item permission number		
Item permission date		
Manufacturing no.		
Warranty period	1 year from the date of purchase	
Date of purchase	MM / DD / YY	
Customer column	Hospital name: Address: Name: Phone:	
Seller name		
Manufacturer name		

※This product is “medical equipment.”

※Thank you for buying FC1400

※This product has passed thorough quality control and strict inspections.

※The criteria for compensation in relation to repair, replacement, or refund for this product shall be governed by the “consumer damage compensation regulations” announced by the Ministry of Strategy and Finance.



Headquarter & International Sales & service

Bionet Co., Ltd. :

5F, 61 Digital-ro 31 gil Guro-gu, SEOUL
08375, REPUBLIC OF KOREA

Tel : +82-2-6292-6410 / Fax : +82-2-6499-7789 / e-mail: sales@ebionet.com

Website: www.ebionet.com

U.S.A sales & service representative

Bionet America, Inc. :

2691, Dow Ave, Suite B
Tustin, CA 92780 U.S.A.

Toll Free: 1-877-924-6638 / Fax: 1-714-734-1761 / e-mail: support@bionetus.com

Website: www.bionetUS.com

European sales & service representative

CMC Medical Devices & Drugs S.L.

C/ Horacio Lengo N° 18,
CP 29006, Málaga, Spain

Tel +34-951-214-054 / Fax +34-952-330-100

E-mail: info@cmcmmedicaldevices.com

Website: www.cmcmmedicaldevices.com